

DeepView – The Swiss-PdbViewer

User Guide

v. 3.7

<http://www.expasy.org/spdbv/>

DeepView – Swiss-PdbViewer user guide. Since there was a strong demand for a printable version of a DeepView user guide, we decided to prepare this manuscript to complement the documentation and tutorial found on the web site. We are aware that this user guide is still incomplete in some chapters, there are references missing, etc.

Please help us to make this user guide useful for you: If you find any errors or inconsistencies, or you don't find an important piece of information, please let us know.

The DeepView Team

Geneva, 13 September, 2001

GlaxoSmithKline R&D
World Trade Center I
Rte de l'Aéroport 10
1215 Geneva 15, Switzerland

Contents

Preface	iii
Introduction	1
I. Overview	1
II. Working Environment.....	1
Installing DeepView	4
I. Requirements and Installation	4
II. DeepView Directories	6
STARTING a DeepView Session	9
I. Loading Files	9
II. Displaying Windows	10
III. Obtaining Help.....	11
Ending a DeepView Session	13
I. Saving Data	13
II. Closing DeepView	14
Basic DeepView Commands	15
I. Using the <i>Toolbar</i>	16
a. Using the tools.....	17
b. Using the menus.....	21
c. Special commands.....	28
II. Using the <i>Control Panel</i>	29
Using the <i>Layers Infos</i> Window.....	34
Advanced DeepView Commands	37
I. Working on a Layer	37
a. Modifying commands	38
b. Searching commands	46
c. Computing commands	50
d. Crystallographic commands.....	58
II. Working on a Project	64
a. Merging commands.....	67
b. Superposing commands	68
c. Alignment commands	73
Homology Modeling	75
I. Loading Files	77
II. Generating a Modeling-Project	79
III. Submitting a Modeling-Project.....	83
IV. Evaluating and Improving the Model	84
Display Modes	85
I. Non Stereoscopic Modes	86
II. Stereoscopic Modes	88
Setting Preferences	91
I. Overview	91
II. Setting Preferences.....	92
Annex 1: List of Key Modifiers and Menus	103

I. Key Modifiers.....	103
II. List of Menus	104
Annex 2: Scripting Language	110
I. Using Scripts	110
II. Scripting Language	110
III. List of Commands.....	113
Annex 3: Hardware Requirements.....	130
Annex 4: CALCULATIONS.....	132
I. Connect.....	132
II. Secondary structure detection	132
III. Mutations	132
IV. Building loops.....	133
V. Molecular surfaces	133
VI. Electrostatic potentials.....	133
VII. Electron density maps	134
VIII. Solvent accessibility.....	134
IX. Matrices	135
X. Threading energy / mean force potential (PP)	135
XI. FORCE FIELD ENERGY (FF).....	135
XII. transformation matrices.....	135
XIII. RMSD	135
XIV. Sequence Similarity	135
Annex 5: Glossary	136
References.....	137

Preface

Acknowledgements

The following manual has been prepared by Mercé Ferres in the Protein Structure Bioinformatics group of GlaxoSmithKline Research and Development S.A., Geneva with contributions from Nicolas Guex, Alexander Diemand and Torsten Schwede. We would like to thank all our users who have contributed innumerable suggestions, bug reports and new ideas that led to the development of DeepView – the Swiss Pdb Viewer in its current form. We are especially grateful to Gale Rhodes (University of Maine), Simon Andrews (BBRC) and Joe Krahn (NIEHS) for continuously supporting our efforts.

To learn more about molecular modeling and molecular visualization, we would encourage you to refer to the following Tutorials:

Gale Rhodes: The Molecular Modeling Tutorial for Beginners

<http://www.usm.maine.edu/~rhodes/SPVTut/>

The DeepView advanced tutorial

<http://www.expasy.org/spdbv/text/tutorial.htm>

Structure of this manual

This manual has been organized in "points" describing certain features or functions of DeepView – Swiss-PdbViewer. The first chapters describe "simple" operations needed to open and display molecular structures, while more complex manipulations are provided in later chapters.

DeepView – Swiss-PdbViewer has been designed to work under different operating systems (Macintosh, Windows, Linux, Irix 6.x), i.e., the commands mentioned in this manual apply to all versions of the program. However, not all functions using the keyboard could be mapped consistently between all different OS (e.g. the ALT – CTRL keys). In these cases, this manual will provide a table of different keyboard-settings.

Legal Disclaimer

The authors reserve the right to change, without notice, the specifications, drawings and information contained in this manual. While every effort has been made to ensure that the information contained in this manual is correct, the authors and GlaxoSmithKline Research and Development S.A., Geneva (herein after called GSK) do not assume responsibility for any errors, which may appear. DeepView – the Swiss-PdbViewer is provided without warranty of any kind whether express, statutory or implied, including all implied warranties of merchantability and fitness for a particular purpose.

DeepView – Swiss-PdbViewer is provided on an "as is" basis. The limited license grant means that you may not do the following with Swiss-PdbViewer: decompile, disassemble, reverse engineer, modify, lease, loan, sell, distribute or create derivative works based upon the Swiss-PdbViewer software in whole or in part without written permission of the authors; transmit Swiss-PdbViewer to any person, except if the original package and its whole original content is transmitted, and that this person accepts to be bound by the terms and conditions of this software license agreement and warranty.

Neither the authors nor GSK shall in any event be liable for any direct, consequential, incidental, indirect or special damages even if advised of the possibility of such damages. In particular, the authors and GSK shall have no liability for any damage loss or corruption of data or programs stored in or used in conjunction with DeepView – Swiss-PdbViewer, nor shall the authors or GSK be liable for the cost of retrieving or replacing damaged lost or corrupted data. If for any reason a court of competent jurisdiction finds any provision of this license to be unenforceable, the other provisions of this limited warranty and software license agreement shall remain in effect without limitation.

All products mentioned in this user guide are trademarks of their respective companies.

INTRODUCTION

I. OVERVIEW

DeepView – the Swiss-PdbViewer (or **SPDBV**), is an interactive molecular graphics program for viewing and analyzing protein and nucleic acid structures. In combination with **Swiss-Model** (a server for automated comparative protein modeling maintained at <http://www.expasy.org/swissmod>) new protein structures can also be modeled.

Annex 5: Glossary provides an extended dictionary for DeepView terminology. To facilitate understanding of the following chapters, some essential terms are introduced here:

A **molecular coordinate file** (e.g. *.pdb, *.mmCIF, etc.) is a text file containing, amongst other information, the atom coordinates of one or several molecules. It can be **opened** from a local directory or **imported** from a remote server by entering its **PDB accession code**. The content of one coordinate file is loaded in one (or more) **layers**, the first one will be referred to as the "**reference layer**".

DeepView can simultaneously display several layers, and this constitutes a **project**. When working on projects, the layer that is currently governed by the *Control Panel* is called the **currently active layer**. Each molecule is composed of **groups**, which can be amino acids, hetero-groups, water molecules, etc. and each group is composed of **atoms**.

Non-coordinate files contain specific information other than atom coordinates. **Molecular surfaces**, **electrostatic potential maps**, and **electron density maps** are examples of non-coordinate files, which can either be computed by DeepView, or loaded from specialized external programs.

II. WORKING ENVIRONMENT

DeepView can display up to eight interconnected interactive windows. This section presents the general purpose of every DeepView window, each of which will be fully described later.

1 • **Graphic window** (see 23, 167)

It is used to visualize loaded molecules, which can be rotated, translated and zoomed.

Display of the coordinate axis is optional. Molecular surfaces, electrostatic potential maps, and electron density maps can also be displayed on the *Graphic* window.

2 • **Control Panel** (see 70)

This table-like window is for controlling the visual representation of the currently active layer.

It lets you enable the display of backbones, side chains, labels, molecular surfaces, and ribbons for each group; and set the colors for the different objects on display.

3 • **Toolbar** (see 38 – 40)

Contains the menus and tools of the program.

These let you analyze the loaded molecules and use Swiss-Model in combination to model new structures.

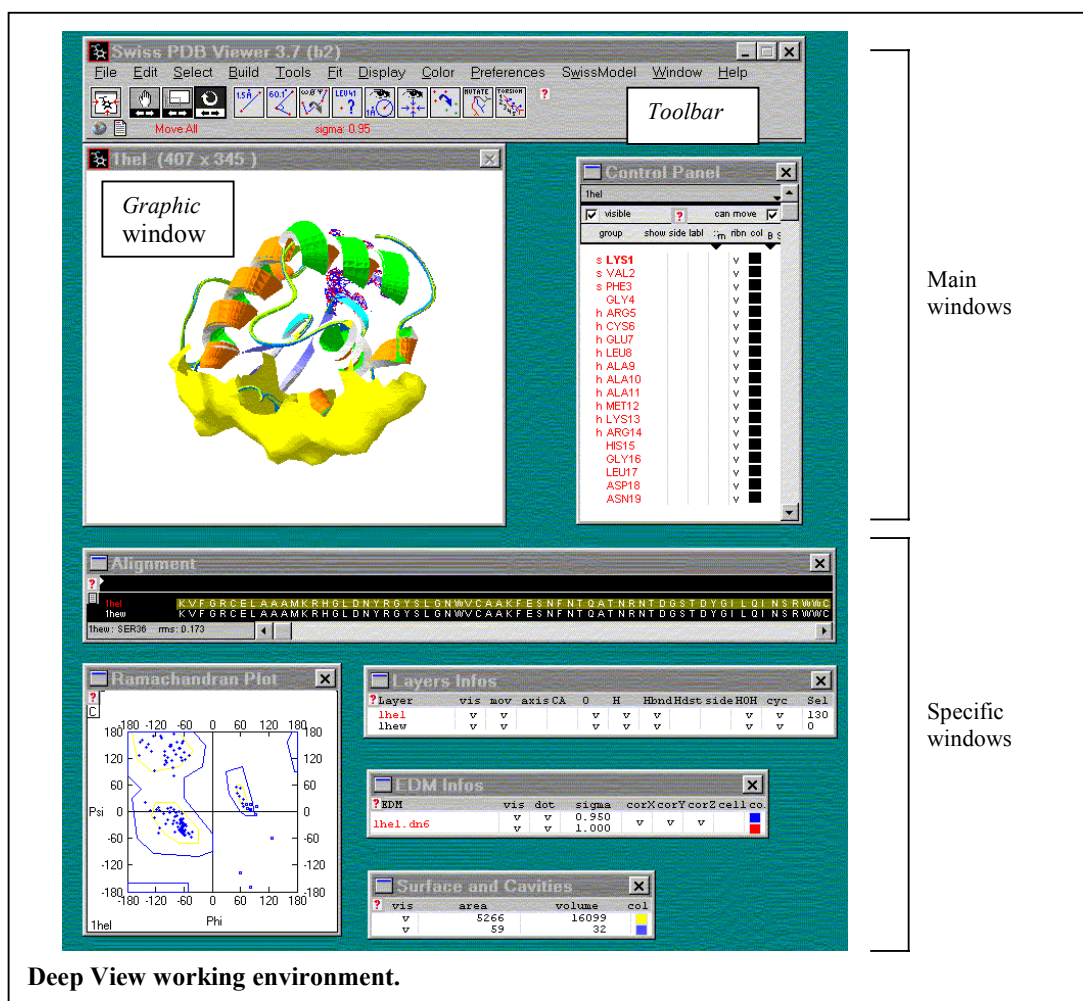

4 • *Layers Infos* window (see 84)

This table-like window is for controlling the display of individual layers.

You can toggle on and off the visualization and movement of layers, and enable the display of certain objects (e.g. H-bonds or water molecules), for each layer.

5 • *Alignment* window (see 114)

Shows the amino-acid sequence of loaded proteins in one-letter abbreviations.

This window is used to compare and to align sequences of two or more proteins. During homology modeling, it allows correcting the alignment of target sequences onto the templates.

6 • *Ramachandran Plot* window (see 93)

Displays a Ramachandran plot.

Each dot on the plot gives the ϕ and ψ angles of one selected residue of the currently active layer. Ramachandran plots are used to judge the quality of a model, by finding residues whose conformational angles lie outside allowed regions.

7 • *Surface and Cavities window* (see 102)

Gives the surface (\AA^2) and volume (\AA^3) of a molecule and its cavities.

This window can only be displayed if a molecular surface has been computed. It is mainly for information purposes, but can also be used to center the view on specific cavities.

8 • *Electron Density Map Infos window* (see 103)

This is a table-like window that lets you control the appearance of electron density maps and electrostatic potential maps.

9 • *Text windows*

In addition to all previously described windows, you can open many *Text windows* for viewing text files such as PDB files, energy reports, BLAST results, help texts, etc.

Text files cannot be edited or printed directly in DeepView. Please use any text editor for this purpose.

INSTALLING DEEVIEW

I. REQUIREMENTS AND INSTALLATION

10 • Requirements

Platform	Required Hardware	Required Operating System
PC	Pentium or 486DX.	Win 95, 98, 2000, NT4 Open GL
Mac	Power Mac (Mac68K are no longer supported). 256 colors monitor. Extended Keyboard highly recommended.	Open GL (QuickDraw3D no longer supported)
Linux	US Keyboard. 3 button mouse.	Linux for PC (with glibc-2.0 or higher). Preferably RedHat X11R6 with at least 16bits. MESA libraries.
Irix	02, Octane	IRIX 6.x (preferably 6.5) (IRIX 5.3 no longer supported).

NOTE:

See ANNEX 3: HARDWARE REQUIREMENTS for hardware stereo support.

11 • Installing DeepView on PC

DeepView can be downloaded from <http://www.expasy.org/spdbv/> or any of the mirror sites mentioned there.

a) Download & install Swiss-PdbViewer.

DeepView is distributed either as a self extractable archive (.exe) or as a zip archive (.zip):

(.exe): Double click the file. By default, a directory called **spdbv** will be created in your C: drive.

You can move this directory where you want on your hard drive. Be sure to maintain the directory content (see points 15-20). To launch DeepView, double click the application icon (.

(.zip): The file can be expanded using WinZip. In this case, be sure to configure WinZip so as to keep the directory hierarchy.

The following steps b) – f) are optional.

b) Download *Swiss-PdbViewer Loop Database* (2.45 Mb).

This step is useful if you intend to do standalone modeling, or for teaching purposes. To be able to use the loop database, put it into the *_stuff_* directory (see point 15).

c) Download the *User Guide* (740 Kb).

This step is useful if you want to consult this user-guide from a computer not connected to the network. To be able to consult the help directly from within DeepView, place the content of this folder into the *_stuff_* directory.

d) Download the *Tutorial Material* (325 Kb).

This step is useful to learn how to use DeepView by looking at real examples.

e) Download PROSITE pattern file (<http://www.expasy.org/prosite/>)

DeepView can search a sequence for PROSITE patterns, if you download the pattern file *prosite.dat* into the *usrstuff* directory.

f) Download and install POV-Ray.

This step is useful only if you intend to make ray-traced images from your molecules.

NOTE:

OpenGL is included in all current Windows versions. If during installation of DeepView a *missing glu.dll* or *missing opengl32.dll* error message is displayed, this means that OpenGL is not installed correctly on your system. Please refer to your graphic card manual or ask your graphic card manufacturer for support. Standard OpenGL DLLs are available from the Microsoft web site <http://www.microsoft.com>.

Windows NT: The **DeepView** root directory and the tree below must not be write-protected for the user executing the program because DeepView will create several temp-files during runtime.

12 • Installing DeepView on Mac

DeepView can be downloaded from <http://www.expasy.org/spdbv/> or any of the mirror sites mentioned there.

a) Download *OpenGL* from <http://www.apple.com/openGL> and install it (if it is not yet present on your system). This step is optional, but allows rendering nice images.

b) Download Swiss-PdbViewer

The following steps are optional.

c) Download Swiss-PdbViewer Loop Database (3.44 Mb).

This step is useful if you intend to do standalone modeling, or for teaching purposes. If you have a program that can expand *.zip files, you can download the .zip version which is 2.45Mb. To be able to use the loop database, put it into the *_stuff_* directory (see point 15).

d) Download the User Guide (698 Kb).

This step is useful if you want to consult this user-guide from a computer not connected to the network. To be able to consult the help directly from within Swiss-PdbViewer, place the content of this folder into the *_stuff_* directory.

e) Download the Tutorial Material (512 Kb).

This step is useful to learn how to use DeepView by looking at real examples.

f) Download POV-Ray (<http://www.povray.org>)

This step is useful only if you intend to make ray-traced images from your molecules.

NOTE:

If your browser starts to display a lot of text instead of prompting you where to save the program, click on the link during about 2 seconds until a pop-up menu appears. Then choose the option *Save link as...* and check that *Source* is displayed in the pop-up, not *Text*. Then drag the downloaded archive file onto *Stuffit Expander*.

13 • Installing DeepView on Linux

DeepView can be downloaded from <http://www.expasy.org/spdbv/> or any of the mirror sites mentioned there.

a) Download Swiss-PdbViewer

b) tar xzf spdbv35-Linux.tar.gz

c) cd SPDBV_DISTRIBUTION

d) ./install.sh

The Linux version is a port of the Macintosh version done using a preliminary release of Latitude for Linux kindly made available by Metrowerks Inc. We wish to thank Kevin Buetner for his support, and Greg Galanos for allowing us to release a version of DeepView that makes use of Latitude.

NOTE:

An error might occur in loading shared libraries *libMesaGL.so.3* because the newer *Mesa* now uses different names for the libraries than those with which DeepView has been linked with. Libraries are now called *libGL.so* and *libGLU.so* instead of *libMesaGL.so* and *libMesaGLU.so*.

However, since the new *Mesa* is completely backward compatible, it should not harm DeepView from working properly. Therefore, there is no need to install an old *Mesa* version, and just a little adjustment is needed. If you can get root access to your Linux box, make the following symbolic links from the new libraries to the old names:

```
ln -s /usr/X11R6/lib/libGL.so.1.2.0 /usr/X11R6/lib/libMesaGL.so.3
```

```
ln -s /usr/X11R6/lib/libGLU.so.1.2.0 /usr/X11R6/lib/libMesaGLU.so.3
```

and then run `/sbin/ldconfig` to make the system remember this changes. (This is assuming that the libraries are installed under `/usr/X11R6/lib`. If this is not correct, please adjust the above commands with the correct location.)

14 • Installing DeepView on Irix

DeepView can be downloaded from <http://www.expasy.org/spdbv/> or any of the mirror sites mentioned there.

a) Download Swiss-PdbViewer v3.7b2 (stable Beta version, 6.0 Mb)

b) gunzip -c spdbv35-IRIX.tar.gz | tar xf -

c) cd SPDBV_DISTRIBUTION

d) install.sh

II. DEEPVIEW DIRECTORIES

Depending on whether you installed the optional material or not, the `spdbv` root-directory will contain the following directories and subdirectories:

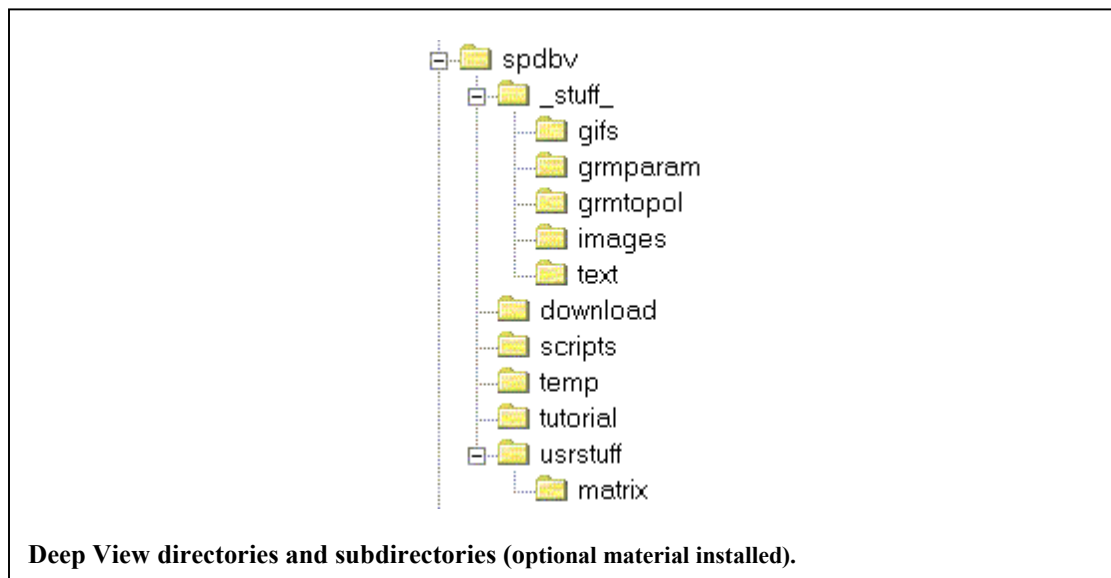

15 • *_stuff_* directory

This directory contains files used by DeepView internally, and cannot be altered.

16 • *download* directory

Stores all files imported from the server and should be cleared from time to time.

<i>download</i> directory	
Files	Description
*.pdb files	PDB and ExPDB files
*.sw files	SWISS-PROT files
*.txt files	Keyword search results, BLAST results, PROSITE documentation, etc.

17 • *scripts* directory

Contains scripting examples and a manual for the use of scripts (see Annex 2: Scripting Language)

18 • *temp* directory

Stores all files generated by DeepView, such as energy reports (see point 106), PROSITE search results (see point 99), alignments (see point 121). Although its content is usually cleared when DeepView is closed, it might be necessary to clear it from time to time.

19 • *tutorial* directory

This supplementary directory contains the tutorial and all files needed to run the examples given in the tutorial.

20 • *usrstuff* directory

This is the “User’s stuff” directory, which stores the settings and the default preferences:

<i>usrstuff</i> directory	
Files	Description
recfile.ini:	Contains the five last loaded files
prosite.dat:	Contains all PROSITE patterns. The user has to install this file by retrieving it from the ExPASy site (http://www.expasy.org/prosite/).
Default.prf	Contains the default preferences (see point 146)
Subdirectory	Description
matrix	Contains all matrices that can be used for sequence alignments, PAM 200 being the default matrix (see annex 162).

Starting a DeepView Session

Initiating a DeepView session means:

- displaying molecules by loading molecular coordinate files,
- displaying optional objects by loading molecular surfaces, electrostatic potential maps and electron density maps (molecular surfaces and electrostatic potential maps can also be computed, see points 102 and 103),
- displaying the required windows.

All these actions can be achieved by using the *File* and *Window* menus of the *Toolbar*, as explained in this chapter.

I. LOADING FILES

21 • Loading molecular coordinate files

The *File* menu offers the following commands to load a molecular coordinate file. This can be a PDB, mmCIF, or MOL file:

File menu	
Command	Action
<i>Open PDB File</i>	Displays a dialog box that allows loading a PDB file by selecting it.
<i>Open mmCIF File</i>	Displays a dialog box that allows loading an mmCIF file.
<i>Open MOL File</i>	Displays a dialog box that allows loading a Molecular Design Limited MolFile (MDL MolFile).
<i>Import</i>	Displays a dialog box that allows doing one of the following: 1- Retrieving PDB files from a local directory, by typing the molecule accession code and selecting <i>Grab from disk: PDB File</i> . <i>NOTE:</i> The path of the local directory, which is the directory in your computer that contains your own collection of PDB files, needs to be specified (see point 164). 2- Retrieving PDB, SwissProt-sequence and SwissProt-text files via a special DeepView network server. You achieve this by typing the molecule accession code or its SwissProt identification and selecting the appropriate button under <i>Grab from server</i> . <i>NOTE:</i> The network server must be configured (see point 163). 3- Keyword Search for PDB / ExpDB files available on the server using the + (AND) and - (NOT) connectors. A list of the PDB entries is displayed. To load a file from the given list, just click its name appearing in red. If a PDB entry contains more than one chain, several ExpDB file names are available. Click the right name to load the whole PDB entry (e.g. 1a00), and click the left name to load just one chain (e.g. 1a00c loads only chain C).

The bottom of the *File* menu also provides a short list with the five recent files (coordinate and non-coordinate files) that were loaded in previous DeepView sessions.

Other ways to load molecular coordinate files include:

Platform	Load a molecular coordinate file by...
<u>Windows</u>	dragging one or several PDB files onto the <i>Toolbar</i> . Only valid for PDB files.

<u>Mac</u>	dragging one or several PDB file icons onto the Swiss-PdbViewer icon. Only valid for PDB files.
<u>Linux and Irix</u>	typing a command line argument, e.g. <code>\$>spdbv pdb1.pdb</code> .

NOTE:

Mac, Linux and Irix: These actions launch DeepView and load selected files or, if DeepView is already running, add selected files into the workspace.

22 • Loading non-coordinate files

The *File* menu offers the following commands to load a non-coordinate file:

File menu	
Command	Action
<i>Open Text File</i>	Displays a dialog box that allows opening any text file, including scripts. Text files are displayed in a simple window with a scrollbar. (Shortcut: Ctrl + click  icon in the bottom left corner of the <i>Toolbar</i>).
<i>Run Script</i>	Displays a dialog box that allows opening and executing a script file. For the use of scripts see Annex 2: Scripting Language.
<i>Open Surface</i>	Allows loading a molecular surface in three different file formats: the surface might have been computed and saved from a previous DeepView session (*.sfc) or written by MSMS [] or GRASP [].
<i>Open Electrostatic Potential Map</i>	Allows loading an electrostatic potential map in three different file formats: the map might have been computed and saved from a previous DeepView session (*.sph) or written by external programs (*.phi).
<i>Open Electron Density Map</i>	Allows loading electron density maps in either DN6, CCP4, or X-PLOR formats (*.dn6, *.map, *.txt). []

II. DISPLAYING WINDOWS

For an overview of all DeepView windows see points 1-9.

23 • Initial windows location

The first time you use DeepView and load a molecular coordinate file, the program opens the *Toolbar*, the *Graphic* window and the *Control Panel*, as shown on the figure below. When closing DeepView, the program remembers which windows were open and their locations. So if you already ran the program, window locations will be those of your previous session. Once a molecule is loaded, use the *Window* menu to manage the display of windows.

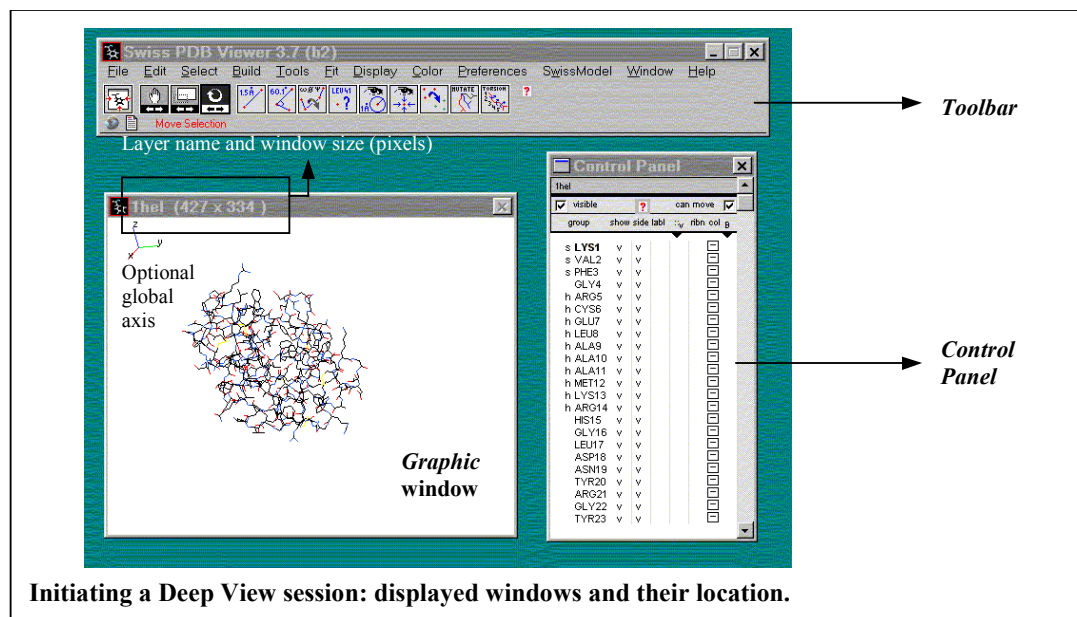

24 • Displaying/closing a window

Under the *Window* menu, click the name of a window to open it or to send it to front. An *Electron Density Map* window or a *Cavities* window can only be displayed if an electron density map or a molecular surface were loaded (or computed, see point 102). To close a window, follow the normal procedure of the operating system.

25 • Linking the *Toolbar* and the *Graphic window*

The *Toolbar* and the *Graphic window* can be linked, by checking *Link Toolbar and Graphic Window* under the *Window* menu. Both windows will then move together when one of them is moved.

NOTE:

Problems were reported when this option is enabled on some Linux and Irix systems.

26 • Bringing a *Text* window to front

Click *Window>Text* to bring to front the first-loaded *Text* window.

III. OBTAINING HELP

According to the platform, look under one of the following menus:

Platform	Look under...
<u>Windows</u>	<i>Help</i> menu
<u>Mac</u>	<i>Apple</i> menu
<u>Linux and Irix</u>	<i>Info</i> menu

These menus contain commands that allow:

- obtaining information about DeepView,
- obtaining help in using DeepView,
- updating the program.

27 • Obtaining information about DeepView

"*About Swiss-PdbViewer*" will display the DeepView "splash" screen, with the current version of the program and a list of authors.

28 • Obtaining short help about a particular window

Either click its small red question mark, or select the window under the *Help*, *Apple* or *Info* menus (according to the platform).

29 • Obtaining detailed help about all DeepView commands

Under the *Help*, *Apple* or *Info* menus (according to the platform), click one of the following commands:

<i>Help, Apple or Info</i> menus (according to the platform)	
Command	Action
<i>WWW Manual</i>	Opens your web browser to the HTML User Guide at the DeepView Home Page.
<i>Local Manual</i>	Opens your web browser to the HTML manual stored on your computer, provided that you have downloaded and installed it in your <i>stuff</i> directory (see point 15).
<i>User Defined Links</i>	Opens your web browser to the page "user.htm" in your <i>usrstuff</i> directory, and lets you set your favorite links to go quickly where you want on the net, directly from within DeepView (see point 20).

30 • Updating the program (not implemented yet)

Under the *Help*, *Apple* or *Info* menus (according to the platform), click *Update Swiss-PdbViewer*: the program will look in the server for a new version of DeepView, or for updated library files, and will automatically download and install them on your computer.

Ending a DeepView Session

During a DeepView session, you might have loaded several molecular coordinate files (see point 21), displayed objects around them. As DeepView will immediately quit when you invoke the *Exit* command (see point 36), before ending your session, you might want to:

- save your data,
- systematically close your files.

These actions can be achieved by using the *File* menu of the *Toolbar*.

I. SAVING DATA

Select *File>Save*: this command offers a submenu to save data and images.

31 • Saving molecular coordinate files

<i>File>Save</i> command	
Subcommand	Action
<i>Layer</i>	Saves the currently active layer in PDB format. In addition to atom coordinates, saved data include the current <i>Control Panel</i> settings, the current view orientation, the background color, and any added bonds, except hydrogen-bonds. The REMARKs (journal references, statistics, etc.) from the originally opened PDB file are not included. (Other programs should be able to read the atom coordinates saved in this format, but will ignore the additional information saved by DeepView).
<i>Project</i>	Saves all layers in a single PDB file (see point 113). The saved file contains the same data as above. (Other programs should be able to read the atom coordinates, but will not distinguish the different layers).
<i>Save Selected Residues</i>	Saves the currently selected groups from all layers to a PDB file.
<i>mmcif</i>	Saves a molecular coordinate file to an mmCIF file. (This format will eventually replace the current PDB format).

32 • Saving non-coordinate files

<i>Surface</i>	Saves a surface to a SPDBV surface file (*.sfc).
<i>Electrostatic Potential</i>	Saves a computed electrostatic potential map to an SPDBV potential file.
<i>Sequence (FASTA)</i>	Saves the sequence of the currently active layer in FASTA format (single letter codes).
<i>Alignment</i>	Saves the current sequence alignment, formatted exactly as seen by clicking the page icon on the left side of the <i>Align</i> window.
<i>Ramachandran Plot Values</i>	Saves a simple list of angles for selected residues of the currently active layer. You must first open the <i>Ramachandran Plot</i> window to calculate the angle values. The file contains, for each residue, the layer name, the 3-letter residue name, the secondary structure type ('H', 'S' or '), the peptide dihedral bond angle (ω), and the backbone conformational dihedral angles (ϕ and ψ).

33 • Saving images

<i>Image</i>	Saves an exact copy of the current <i>Graphic</i> window contents. The format depends on the platform: <u>Mac</u> saves in PICT format. <u>Windows</u> saves simple files in Bitmap format (*.bmp) and OpenGL files in Targa format (*.tga). <u>Linux</u> and <u>Irix</u> save in Targa format. To convert files to other formats, use image file converters, such as <i>convert name.tga name.tif</i> (<u>Linux</u> and <u>Irix</u>), or <i>Graphic Converter</i> (<u>Mac</u>).
<i>Stereo Image</i>	Saves two images corresponding to the left and right eye view according to the current stereo settings. The file format depends on the platform, as described above.
<i>POV3 Scene</i>	Saves object data to a POV-Ray formatted file, with options for size, anti-aliasing, and for making a stereo pair (see point 141). <u>Linux</u> and <u>Irix</u> : Files are saved in the directory defined in the environment variable SPDBV_POV_PATH. Pressing the <i>Render</i> button will run POV-Ray and display the result, provided that POV-Ray is installed. The script defined in the environment variable SPDBV_POV is executed.
<i>Mega POV scene</i>	Same as above, but with smoother colors for molecular surfaces (see point 141).

II. CLOSING DEEPVIEW

34 • Closing molecular surfaces, electrostatic potential maps and electron density maps

Point *File>Discard*: in the associated submenu select the object to be closed, which will be removed from the currently active layer. (This step is useful to free some memory after manipulating big objects.)

35 • Closing layers

Click *File>Close* to close only the currently active layer.

Click *File>Close All Layers* to close all layers at once. This command is only active if you are working on a project (several layers were loaded).

36 • Closing the program













Click *File>Exit* to quit DeepView. The next time you use DeepView, the program will remember which windows were open and their locations.

Note that DeepView never asks if you want to save changes in files or projects before closing them, nor before quitting the program.

Basic DeepView Commands

37 • Classification

The following basic DeepView commands are mainly for setting the visualization of molecules by selecting, displaying, and coloring objects, as well as for analyzing molecules by measuring distances and angles between atoms. They can be grouped according to their location:

Location	Command	Action achieved	See point	
Toolbar	Tools		Center the visible groups	41
			Translate, zoom, and rotate molecules	42
			Measure distances between atoms	43
			Measure bond angles	44
			Measure dihedral angles	45
			Identify groups and atoms	46
			Display/select groups within a distance of a picked atom	47
			Center the model on a picked atom	48
	Menus	<i>Edit</i> commands	Edit the identification of a molecule	49
		<i>Select</i> commands	<ul style="list-style-type: none"> - apply basic selections - select groups by type - select groups by property - select groups by secondary structure - select groups with respect to a reference - select groups by distance - select groups by structural criteria 	50 51 52 53 54 55 56
		<i>Display</i> commands	<ul style="list-style-type: none"> - show/hide various objects - select various views for displaying a molecule - set the style of labels placed by the <i>Control Panel</i> - clear all labels placed by the tools 	57-58 59 60 61
		<i>Color</i> commands	Let you color all or parts of a molecule by different criteria	62-66
	Special		Displays PDB files or opens text files (Ctrl clicking)	67-68
			Provides help on the <i>Toolbar</i>	69
Control Panel	First column	(... <i>A h ALA 22</i> ...)	<ul style="list-style-type: none"> Let you center the model on a specific group Let you select: <ul style="list-style-type: none"> - all groups belonging to a chain - all groups belonging to a secondary structure element - one single group - several individual groups - an interval of groups 	72 73 74 75 76 77
		<i>show/side/labl/ribn</i>	Toggle the display of groups	78-79
			Toggle the display of surfaces	80
		<i>col</i>	Lets you color a molecule and associated graphic objects (ribbon, surfaces)	81
		<i>vis/mov</i>	Toggles on and off the display and movement of layers	82
			Provides help on the <i>Control Panel</i>	83
Layers Infos window	Header		Manages the display of projects	85
			Provides help on the <i>Layers Infos window</i>	86

I. USING THE *TOOLBAR*

38 • The *Toolbar*

The *Toolbar* contains the tool buttons and menus of the program:

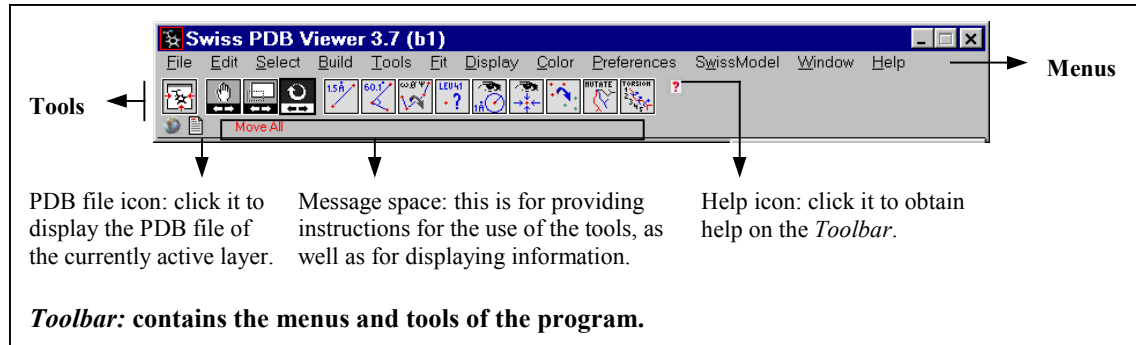

39 • The tools

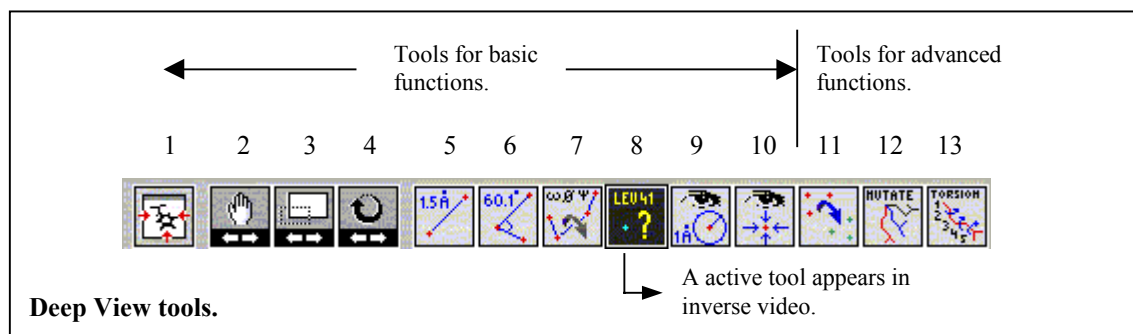

A tool is selected by clicking its icons. To deselect tools 2 to 10, either select another tool or press Esc to activate the rotation tool.

For explanations on tools 11, 12, and 13 (which are for achieving advanced function) see points, 117, 88, and 89, respectively.

Tools 5 to 8 add labels on the *Graphic* window. To remove those labels see point 61.

40 • The menus

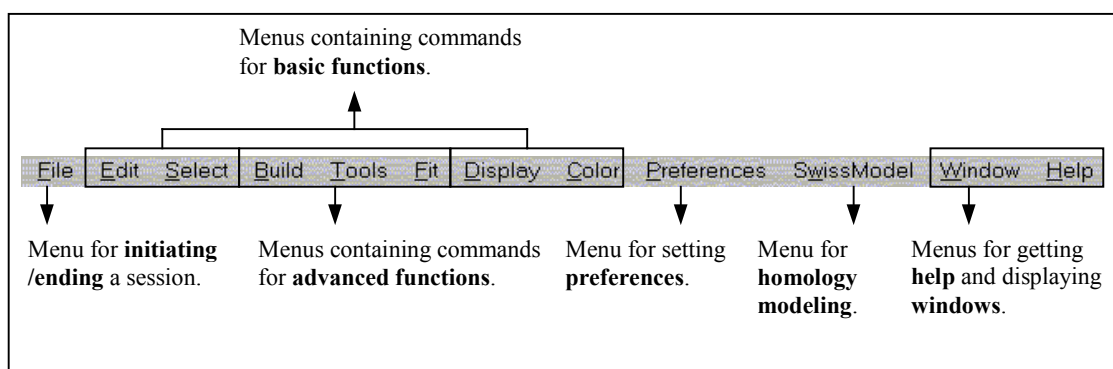

a. Using the tools

41 • Centering a molecule

Button 1 is for centering the molecule: this will be automatically adjusted so that visible residues fit the *Graphic* window. All platforms can also center a molecule by using the "Home" key (oblique arrow on Mac) or the = key.

42 • Translating, zooming, and rotating a molecule

For all platforms, buttons 2, 3, and 4 control movement of the molecule. From left to right, these buttons allow translating, zooming, and rotating the molecule. The currently active button is mapped onto the left mouse button. On the *Graphic* window, the cursor changes to show which button is selected. Pressing tab repeatedly cycles through the three commands from left to right. Holding down the Shift key while pressing tab repeatedly cycles through the three commands from right to left.

Linux, Irix: in addition to buttons 2 to 4, the left, mid, and right mouse buttons provide rotation, zoom, and translation, respectively, provided that the rotate button is selected (mapped on the left mouse button). It is therefore suggested to leave the rotate button selected permanently, so that it is possible to fully control the molecule motion with the three mouse buttons.

Windows: use the left mouse button to rotate a molecule, the right button to translate it, and both buttons to zoom it, provided that the rotate button is selected (mapped on the left mouse button). It is therefore suggested to leave the rotate button selected permanently, so that it is possible to fully control the molecule motion with the two mouse buttons.

When either the translate or the rotate tools are active, the selected movement can be constrained about or along the X, Y, or Z axes by using the following key modifiers:

Platform	X	Y	Z
<u>Windows</u>	F5	F6	F7
<u>Mac</u>	Control	Option	Command
<u>Linux and Irix</u>	Control	Alt	Alt+Control

Rotation and translation can also be applied to selected groups by clicking on the message space below the tools, to switch from "Move All" mode to "Move Selection" mode:

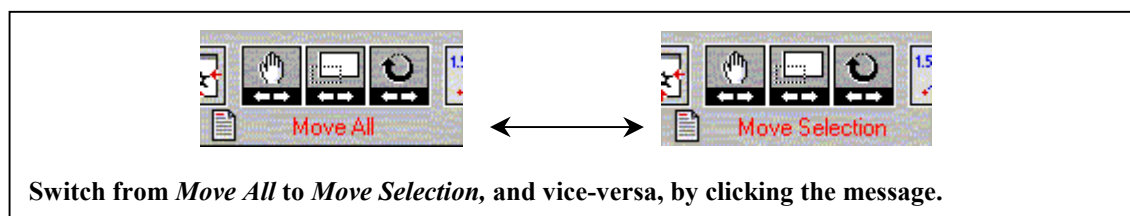

Depending on whether the *Move Selection* mode or *Move All* mode is selected, the atom coordinates of a moved layer will be altered:

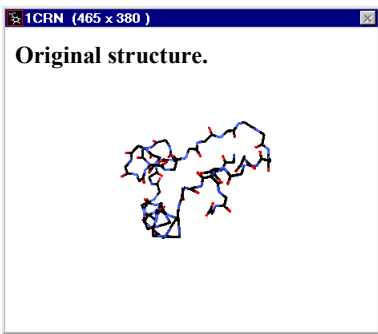

Original structure.

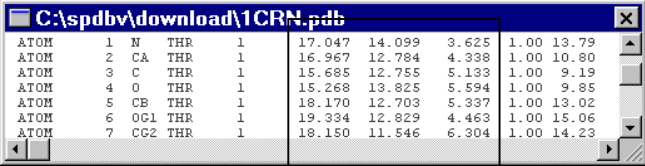

ATOM	1	N	THR	1	17.047	14.099	3.625	1.00	13.79
ATOM	2	CA	THR	1	16.967	12.784	4.338	1.00	10.80
ATOM	3	C	THR	1	15.685	12.755	5.133	1.00	9.19
ATOM	4	O	THR	1	15.268	13.825	5.594	1.00	9.85
ATOM	5	CB	THR	1	18.170	12.703	5.337	1.00	13.02
ATOM	6	OG1	THR	1	19.334	12.829	4.463	1.00	15.06
ATOM	7	CG2	THR	1	18.150	11.546	6.304	1.00	14.23

X, Y, Z coordinates of the first seven atoms of the original PDB file (to display a PDB file see point 67).

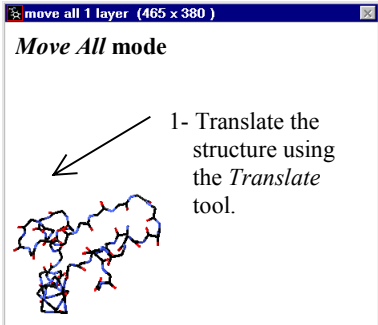

Move All mode

1- Translate the structure using the *Translate* tool.

2- Select *File>Save>Layer* to save the translated structure (see point 31).

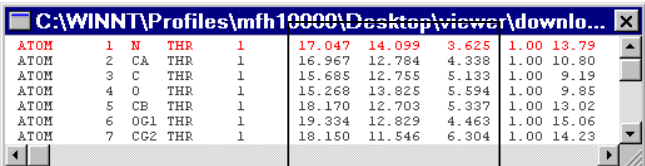

ATOM	1	N	THR	1	17.047	14.099	3.625	1.00	13.79
ATOM	2	CA	THR	1	16.967	12.784	4.338	1.00	10.80
ATOM	3	C	THR	1	15.685	12.755	5.133	1.00	9.19
ATOM	4	O	THR	1	15.268	13.825	5.594	1.00	9.85
ATOM	5	CB	THR	1	18.170	12.703	5.337	1.00	13.02
ATOM	6	OG1	THR	1	19.334	12.829	4.463	1.00	15.06
ATOM	7	CG2	THR	1	18.150	11.546	6.304	1.00	14.23

3- Open the translated structure again and display its PDB file: the X, Y, Z atom coordinates **did not change**.

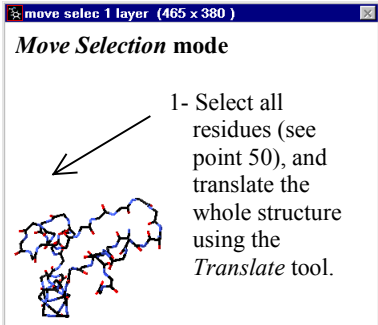

Move Selection mode

1- Select all residues (see point 50), and translate the whole structure using the *Translate* tool.

2- Select *File>Save>Layer* to save the translated structure (see point 31).

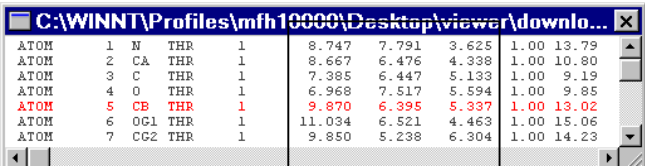

ATOM	1	N	THR	1	8.747	7.791	3.625	1.00	13.79
ATOM	2	CA	THR	1	8.667	6.476	4.338	1.00	10.80
ATOM	3	C	THR	1	7.385	6.447	5.133	1.00	9.19
ATOM	4	O	THR	1	6.968	7.517	5.594	1.00	9.85
ATOM	5	CB	THR	1	9.870	6.395	5.337	1.00	13.02
ATOM	6	OG1	THR	1	11.034	6.521	4.463	1.00	15.06
ATOM	7	CG2	THR	1	9.850	5.238	6.304	1.00	14.23

3- Open the translated structure again and display its PDB file: the X, Y, Z atom coordinates **did change**.

Move All vs. Move Selection modes: implications on the atom coordinates.

43 • Measuring distances between atoms

Buttons 5 is for measuring distances between atoms. Click the button, and follow the instructions that appear in the message space below the toolbar (1. Pick 1st atom; 2. Pick 2nd atom). After you have picked two atoms on the molecule, the distance is shown as a label, along with a dotted line:

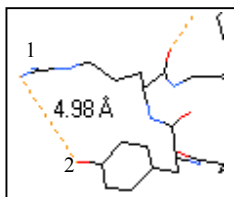

1
2
4.98 Å

Distance measured between two atoms picked on the *Graphic* window.

44 • Measuring bond angles

Button 6 is for measuring bond angles. Click the button, and follow the instructions that appear in the message space below the toolbar (1. Pick **center** atom; 2. Pick 2nd atom; 3. Pick 3rd atom). After you have picked three atoms on the model, the angle is shown as a label, along with a dotted line.

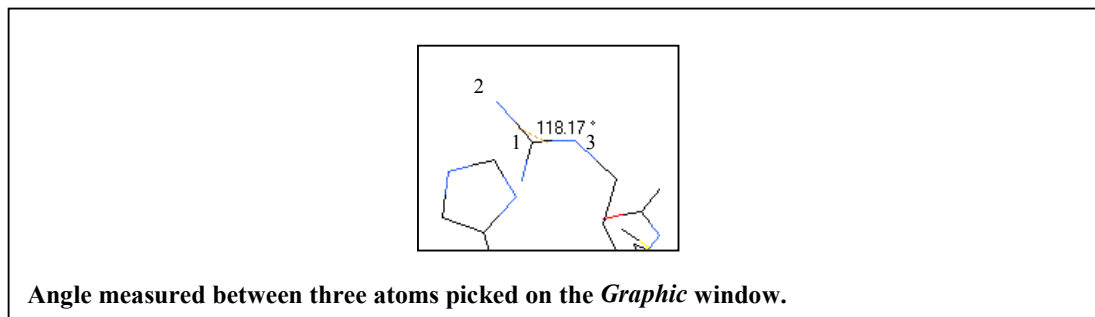

45 • Measuring dihedral angles

Button 7 is for measuring dihedral angles.

Click the button and, following the instructions that appear in the message space below the toolbar, pick one atom. The values for ω , ϕ , and ψ of the amino acid containing the selected atom are displayed on the message space.

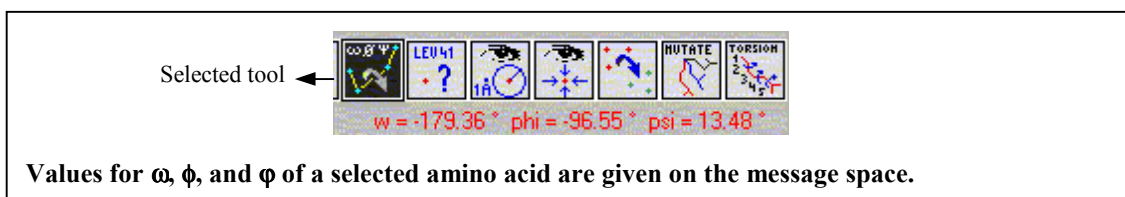

Click the button while holding Ctrl and, following the instructions that appear in the message space below the toolbar, pick 4 atoms. The torsion angle of the four atoms is displayed on the message space.

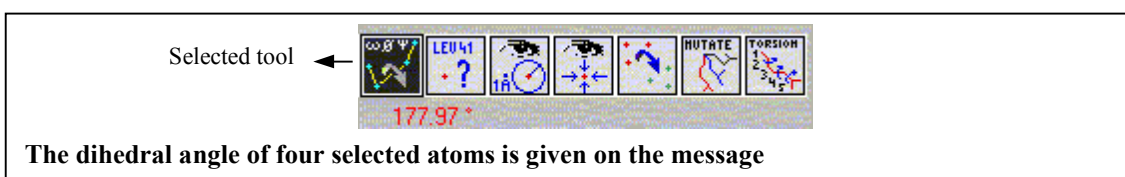

46 • Identifying groups and atoms

Button 8 allows identifying an atom and the group to which the atom belongs. Click the button and pick one atom. The atom type (CA, CB, O...) and the group to which it belongs (LYS116, ASN117...) are displayed both on the molecule and on the message space. In addition, the message space gives the x, y, z atom coordinates and B-factor. (For further ways to label groups on a molecule, see point 78.)

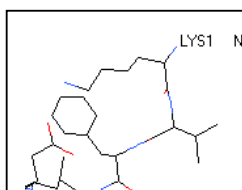

Identification of an atom picked on the *Graphic* window.

Identification of the same atom on the *Toolbar*.

47 • Displaying/selecting groups within a distance of a picked atom

Button 9 allows restricting the display of the molecule on the *Graphic* window, or the selection of amino acids on the *Control Panel*, to groups within a distance of a picked atom. Click the button and, following the instructions that appear in the message space below the toolbar, pick one atom. The *Display Radius* dialog box allows entering a distance and choose one of the following options:

Display Radius

- Add to view groups that are within
- Display only groups that are within
- Select groups that are within
- Add to Selection groups that are within

6.000 Å of the picked

Act on all Layers

Cancel OK

- Adds to a previous display those groups that are within the entered distance of the picked atom.
- Displays groups on the *Graphic window* that are within the entered distance of the picked atom.
- Selects groups on the *Control Panel* window that are within the entered distance of the picked atom,
- Adds to a previous selection those groups that are within the entered distance of the picked atom.

Enter here the distance.

If more than one layer was loaded, the *Display Radius* dialog box lets you enable/disable application of the tool to all layers.

Display Radius dialog box.

48 • Centering the view on a picked atom

Button 10 is for centering the display of a molecule on a selected atom. Click the button and pick one atom. The display jumps to center the molecule on the picked atom. (For centering a molecule on a specific group by using the *Control Panel*, see point 72).

b. Using the menus

Edit menu

49 • Editing the identification of a molecule

The *Edit* menu offers three commands that allow editing the identification of a molecule:

<i>Edit</i> menu	
Command	Action
<i>Rename Current Layer</i>	Displays the <i>Rename Layer Components</i> dialog box, which allows renaming the currently active layer, and changing the chain identifier of selected amino acids as well as renumbering them (see figure below).
<i>Rename Selected HETATMs</i>	Displays the <i>Rename HETATMs</i> dialog box, which allows renaming selected hetero groups as well as their atom names (see figure below).
<i>Fix Atoms Nomenclature</i>	Checks if amino acids atom names are conform to the IUAPAC standard. This is useful since files returned from Swiss-Model (see chapter on homology modeling), or files that have been energy minimized with external force fields (see point 107), sometimes contain wrong atom names.

Rename Layer Components

Fields for renaming:
 - the layer,
 - the chain ID of selected groups.

Field for renumbering selected groups.

Rename HETATMs

Field for renaming the selected HETATM.

Field for renumbering the atoms belonging to the selected HETATM (four characters per atom, as in PDB files).

Rename Layer Components and Rename HETATMs dialog boxes.

In addition to these specific commands, the *Edit* menu includes the following commonly used commands:

Undo and *Redo*, which allow undoing and redoing the last action,
Cut, *Copy*, *Paste*, and *Clear* (not implemented yet).

For explanations on all other commands of the *Edit* menu (which consist of advanced commands) refer to the following points:

<i>Edit</i> menu	
Command	See point
<i>Script Commands</i>	Annex 2: Scripting Language
<i>Find Sequence</i>	98
<i>Find Next</i>	98
<i>Search for PROSITE pattern</i>	99
<i>BLAST selection vs. SwissProt</i>	100
<i>BLAST selection vs. ExPDB</i>	100
<i>Assign helix-type to selected aa</i> <i>Assign strand-type to selected aa</i> <i>Assign coil-type to selected aa</i>	97

***Select* menu**

The *Select* menu allows selecting specific groups on the *Control Panel* on the basis of atom properties, residue properties, structure properties, or other criteria. Selected groups appear in red on the *Control Panel*.

If several layers are loaded, shift-clicking a *Select* option allows extending the selection to all layers.

50 • Applying basic selections

Use the following commands of the *Select* menu to achieve the following basic selections:

<i>Select</i> menu	
Command	Action
<i>All</i>	Selects all groups.
<i>None</i>	Deselect all groups.
<i>Inverse Selection</i>	Selects the inverse of a current selection.
<i>Visible groups</i>	Selects those groups for which the backbone, the ribbon, or both, are displayed on the <i>Graphic</i> window.
<i>Pick on screen</i>	Allows selecting groups by picking them on the <i>Graphic</i> window.
<i>Extend to other layers</i>	When working on a project, this command copies selection status from groups in the currently active layer to all other layers, based on the sequence alignment. This command is useful for identifying important counterpart residues for an aligned structure, such as active site residues.
<i>Groups with same color as</i>	Allows picking a residue on the <i>Graphic</i> window, and selects all residues with the same color.

51 • Selecting groups by type

Click *Select>Group Kind*. This displays a submenu to select groups by type:

Select>Group Kind command	
Subcommand	Groups selected
<i>Ala (A)</i> [...] <i>Val (V)</i>	All residues of the chosen type.
<i>G, A, T, C, U</i>	All nucleotides of the chosen type. Non standard nucleotides cannot be recognised, instead, they can be selected as hetero-groups.
<i>HETATM</i>	All groups defined as a hetero-group.
<i>Solvent</i>	All water molecules, i.e. groups named WAT, SOL, HOH or H2O. (NOTE: Water molecules are not loaded by default. To load them, disable <i>Ignore Solvent</i> in the <i>Loading Molecule Preferences</i> dialog box, see point 150).
<i>SS-bonds</i>	Identified Cys-Cys disulfide bonds.

52 • Selecting groups by property

Click *Select>Group Property*. A submenu lets you select amino-acids according to four property categories. It is currently not possible to change which residue belongs to which category, but scripting commands can be used to add a menu that define your own selections (see Annex 2: Scripting Language).

Select>Group Property command	
Subcommand	Groups selected
<i>Basic</i>	Arg, Lys, His
<i>Acidic</i>	Asp, Glu
<i>Polar</i>	Asn, Gln, Ser, Thr, Tyr
<i>non-Polar</i>	Ala, Cys, Gly, Ile, Leu, Met, Phe, Pro, Trp, Val

53 • Selecting groups by secondary structure

Click *Select>Secondary Structure*. A submenu lets you select all residues that belong to a standard secondary structure type, or all amino acids that verify a specific main-chain property.

Select>Secondary Structure command	
Subcommand	Groups selected
<i>Helices</i>	All residues of any helix ("h" in <i>Control Panel</i> window).
<i>Strands</i>	All residues of any strand ("s" in <i>Control Panel</i> window).
<i>Coils</i>	All residues of any coil between two specific secondary structure elements (" " in <i>Control Panel</i> window). Even non-amino acid groups are selected.
<i>non-TRANS aa</i>	Residues with <i>cis</i> - or distorted peptide bonds.
<i>aa with Phi/Psi out of Core Regions</i>	Residues outside of the common α , β , and α_L core regions (see point 93, <i>Ramachandran Plot</i> , []).
<i>aa with Phi/Psi out of Allowed Regions</i>	Residues with unusual ϕ and/or ψ values. Few residues should be here, except for Gly (see point 93, <i>Ramachandran Plot</i> , []).

NOTE:

You can select an individual secondary structure by clicking on a "h", "s" or " " in the second column under the *group* header of the *Control Panel* (see point 74).

54 • Selecting groups with respect to a reference

The following commands presuppose that a structural alignment has been computed (see point 121):

Select menu	
Command	Action
<i>aa identical to ref.</i>	Selects residues that are strictly conserved between the currently active layer and the reference layer (first loaded).
<i>aa similar to ref.</i>	Selects similar residues between the currently active layer and the reference layer (first loaded). By default, the PAM 200 matrix will be used, and the minimum score needed to be considered similar can be modified in <i>Preferences>Alignment</i> (see point 162).
<i>aa matching ref. structure</i>	Selects residues of the currently active layer whose backbone has a RMS deviation to the reference layer inferior or equal to a certain threshold.

55 • Selecting groups by distance

The three following commands prompt the previously described *Display Radius* dialog box (see point 47), which allows selecting groups on the *Control Panel*, or displaying groups on the *Graphic* window, within a distance that you can specify. The dialog lets you extend a selection/display around a previous selection/display, and includes an option to act on all layers.

Select menu	
Command	Action
<i>Neighbors of selected aa</i>	Selects/displays groups with at least one atom within the specified distance of any atom of selected groups.
<i>Groups close to another chain</i>	Selects/displays any group that is near any other group with a different chain ID. This command is useful to highlight residues at the interface of two chains.
<i>Groups close to another layer</i>	Selects/displays any group that is near any other group from a different layer. It applies to all layers, and is useful when interacting chains have been loaded into separate layers.

56 • Selecting groups by structural criteria

Finally, use the five following commands to select groups according to specific structural criteria.

Select menu	
Command	Action
<i>Accessible aa</i>	Selects residues with an accessible surface area higher than a given percentage, which you will be prompted for in a dialog.
<i>aa Making Clashes</i>	Selects residues with atoms too close to atoms of other residues. Since van der Waals radii are not assigned when files are loaded, DeepView looks for atoms that are closer than the minimal H-bond distance (as set in <i>Preferences>H bond detection threshold</i> , when no hydrogen atoms are present). A finer way to find clashes consists in coloring the molecule by force field energy: residues that have a high non-bonded energy (colored in red) are too close to each other.
<i>aa Making Clashes with Backbone</i>	Selects groups with at least one atom too close to the backbone of another group.
<i>Sidechains lacking Proper H-bonds</i>	Selects those buried residues whose sidechain could make an H-bond or a salt-bridge, but do none (see point 101, computing H-bonds). Few should occur in good structures.
<i>Reconstructed</i>	Selects residues with reconstructed sidechains. These may have been built automatically for

<i>amino-acids</i>	residues with missing atoms, which often occurs for highly mobile surface residues. Automatic reconstruction can be disabled (see point 149).
--------------------	---

Display menu

The *Display* menu is mainly comprised of *Show* and *View* commands. These are checkbox commands, which turn on and off various viewing options. Some of these options are also available through the *Layer Infos* window.

57 • *Show* commands

Show commands consist of self-explanatory toggles for showing or hiding:

- the global coordinate system axes,
- the carbon alpha trace,
- backbone oxygens,
- sidechains even when backbone is hidden,
- dot surfaces (must have been computed first),
- forces (must have been computed first),
- hydrogens,
- H-bonds (must have been computed first),
- H-bond distances (must have been calculated),
- H-bonds from selection (must have been computed),
- groups with visible H-bonds (H-bonds must have been built).

To compute H-bonds, surfaces, and forces, see points 101, 102, and 106, respectively.

Show commands apply only to the currently active layer, except for *Show Axis*, since all layers use the same coordinate system. To extend a *Show* command to all layers, select it while holding Shift. The most used *Show* commands are readily available through the *Layers Infos* window (see point 85).

58 • *Views* command

This offers a submenu that allows saving a view, resetting a previous view, and deleting a saved view. A view of a molecule is defined by the orientation and perspective of the molecule.

<i>Display>Views</i> command	
Subcommand	Action
<i>Save</i>	Prompts a dialog that lets you name a view to save it. The name of the saved view is then included in the last line of the submenu. <i>NOTE:</i> When saving a layer, all saved views are stored with the layer.
<i>Reset</i>	Displays the original model view, when first loaded.
<i>Delete</i>	Prompts a message reminding how to delete a saved view, i.e. by selecting it while holding down Ctrl.

59 • *View From* command

Allows rotating the molecule to change the point of view. This command is no longer maintained and will be removed in future versions.

60 • Setting the style of the labels placed with the *Control Panel*

Labels for individual groups can be placed by using the tools, as explained above, or by using the *Control Panel* (see points 78-79).

Click *Display>Label Kind* and select a submenu to set the display of the labels placed by using the *Control Panel*:

<i>Display>Label Kind</i> command		
Subcommand	Action	
<i>Group Name</i>	Set the label style by:	Group name, e.g. LEU125.
<i>Atom Name</i>		Atom name, e.g. CA, C, O, N.
<i>Atom Type</i>		Atom type, e.g. C, C, O, N.
<i>Atom Charge</i>		Atom charge, e.g. 0.000, 0.380, - 0.380, - 0.280. Only valid after an energy computation has been made.
<i>Atom Code (GROMOS 96)</i>		Atom code, referring to the GROMOS96 force field, e.g. 12, 11, 1, 5. Only valid after an energy computation has been made.

Selection will apply to all layers.

61 • Clearing user's labels

Click *Display>Label Kind>Clear User Labels* to clear any label added to the molecule by using the tools. Labels added by using the *Control Panel* will not be cleared (see point 78).

For explanations on all other commands of the *Display* menu, refer to the given points:

<i>Display</i> menu	
Command	See point
<i>Slab</i>	138
<i>Stereo view</i>	142-144
<i>Use OpenGL Rendering</i>	140
<i>Render in solid 3D</i>	140

***Color* menu**

The *Color* menu is used to systematically apply colors to the Backbone, Sidechain, Ribbon, Label, and Surface of each group. Backbone & Sidechains can be colored at once.

Look at the **first line of the *Color* menu**. This indicates what object (Backbone + Sidechain, Backbone, Sidechain, Ribbon, Label, or Surface) will be colored by the subsequent coloring operations. The object can be selected by using the pop-up menu associated to this command, or by using the pop-up menu under the header *col* of the *Control Panel* (see point 81).

62 • Coloring objects

Use one of the *Color* menu functions (63) to color the selected object. If a *Color* command is invoked while holding down the Shift key, colors are applied to all layers. If a *Color* command is invoked while holding down the Ctrl key, only selected groups are colored (currently this works only when selecting *Color>by CPK* or *Color>by Other Color*).

63 • *Color* menu, first block

Color menu	
Command	Coloring action
<i>By CPK</i>	Colors the selected object by element type, using a default standard CPK scheme: N=blue, O=red, C=white, H=cyan, P=orange, S=yellow, other=gray. This command is only effective if backbones and/or sidechains are selected for coloring. Default colors can be redefined in <i>Preferences>Colors</i> (see point 154)
<i>By Type</i>	Colors the selected object by residue property: Acidic=red, Basic=blue, Polar=yellow, and Non-Polar=gray (Acidic, Basic, Polar, and Non-Polar). Default colors can be redefined in <i>Preferences>Colors</i> (see point 154).
<i>By RMS</i>	At least two proteins must have been loaded, superposed, and structurally aligned (see points 127-132). Each residue in the active layer will be colored accordingly to its RMS backbone deviation from the corresponding amino acid of the reference protein (the first loaded). <i>NOTE:</i> Colors are mapped from a fixed linear scale, in which dark blue is for RMS = 0 Å, and red is for RMS = 5 Å. A relative scale can be selected in <i>Preferences>General</i> where the best fit is dark blue and the worst fit is red.
<i>By B-Factor</i>	Colors sidechains and backbones, independently, according to their respective largest B-factor per group. A color gradient is used in which blue is for B-factor = 0 Å ² , green is for B-factor = 50 Å ² , and red is for B-factor ≥ 100 Å ² . Ribbons take the colors of sidechains, and surfaces take the color of the B-factor of the nearest atom. In the case of a model returned by Swiss-Model, the B-factor column contains the Model Confidence Factor (see point 135). <i>NOTE:</i> The coloring gradient can be adjusted in <i>Preferences>General</i> to fit the range of B-factor values present in the structure (see point 149).
<i>By Secondary Structure</i>	Colors the selected object according to the three common secondary structure types: Helix=red, Strand=yellow, and Coil =gray. Especially useful for coloring ribbon drawings. Default colors can be redefined in <i>Preferences>Colors</i> (see point 154).
<i>By Secondary Struct. Success.</i>	Produces a gradient along the polypeptide chain from N-terminus (blue) to the C-terminus (red). Each secondary structure element gets a single color, and random-coils are gray. Especially useful for coloring ribbon drawings.

64 • *Color* menu, second block

Color menu	
Command	Coloring action
<i>By Selection</i>	Colors selected residues in cyan and non-selected residues in dark gray. Useful to quickly find where selected residues are located in the model. Default colors can be redefined in <i>Preferences>Colors</i> (see point 154).
<i>By Layer</i>	Each layer gets a single unique color. The layers are colored in order from the first as: yellow, blue, green, red, gray, magenta, cyan, salmon, purple, light green, and brown. The color succession is repeated for additional layers. Ideal for viewing superposed structures.
<i>By Chain</i>	Colors each chain by a different color: yellow, blue, green, red, gray, magenta, cyan, salmon, purple, light green, and brown. The color succession is repeated for additional chains. <i>NOTE:</i> Chains are defined in the PDB file; a break in the modeled polypeptide chain does not signify a new chain.

65 • Color menu, third block

Color menu	
Command	Coloring action
<i>By Alignment Diversity</i>	At least two proteins must have been loaded, superposed, and structurally aligned (see points 127-132). Applies a blue-to-red color gradient to all layers, according to the degree of similarity among all aligned residues. Blue indicates identical or very similar, and red indicates that residues have dissimilar properties (see Annex 4:).
<i>By Accessibility</i>	Each group is colored by its relative accessibility (see Annex 4:). Colors range from dark blue for completely buried amino acids, to red for residues with at least 75% of their maximum surface exposure. The relative accessibility of a residue X is obtained by comparison to a reference value of 100% accessibility computed in an extended conformation in the pentapeptide GGXGG.
<i>By Threading Energy</i>	Colors each residue of the protein according to its energy (computed by a "Sippl-like" mean force potential, see Annex 4: , []). Dark blue means that the threading energy is low (the residue is happy with its environment), red means that the threading energy is high (the residue is not happy with its environment).
<i>By Force Field Energy</i>	Colors each residue according to its force field energy (computed with a partial implementation of the GROMOS 96 []). A dialog lets you choose what kind of interaction you want to compute (bond, angles, improper, electrostatic...) and ask for a text report where detailed energy of each residue is given. Especially useful during refinement of a model as you can color by bond and angle deviations only, and this will identify distorted parts of the protein.
<i>By Protein Problems</i>	The backbone of those residues whose ϕ , ψ angles do not plot in the allowed area of the <i>Ramachandran Plot</i> is colored in yellow. The backbone of proline residues whose ϕ angle deviates more than 25° from the ideal -65° value is colored in red. Buried sidechains of residues that could make H-bonds but do not are colored in orange. Clashes are computed and will appear as pink dotted lines.

66 • Color menu, fourth block

Color menu	
Command	Coloring action
<i>By Other Color</i>	Prompts you for a single color to be applied to the entire layer. It is functionally equivalent to a shift-click on any color box of the <i>Control Panel</i> window (see point 81).
<i>By Backbone, Sidechain, Ribbon, Surface, Label Color</i>	These last five commands are used to copy the current colors set for one object selected here to the object shown in the first line of the <i>Color</i> menu. Use this to save a set of colors in a property you're not using (like surface color) and copy it back later.

NOTES:

Color by CPK is the only coloring command that uses different colors for the different atoms that belong to a group.

For colors by CPK, by type, and by secondary structure, default colors can be redefined in *Preferences>Colors* (see point 154).

c. Special commands

67 • Viewing PDB files

Click the dog-eared page icon to open a text window with the content of the original molecular coordinate file of the currently active layer.

68 • Navigating in text files

Control clicking the dog-eared page icon opens the *Select a TEXT file* dialog to let you open any text file. Very large files are supported, which can be visualized this way.

Many text file elements can be treated as active hyperlinks. When they are clicked they produce an action, for example:

Clicking a SWISS-PROT, PDB or PROSITE accession number (which appear in red in text files) downloads the corresponding file automatically.

Clicking an ATOM line will center the view of the model on this atom and will display only those residues that are within a certain radius of the atom. To edit this radius, see point 167.

Clicking any other line containing the identification of a residue (group name and group number) will center the view on the carbon alpha of the residue.

NOTE: Text files cannot be edited or printed within DeepView.

69 • Obtaining help on the *Toolbar*

Click the small red question mark to obtain help on the *Toolbar*.

II. USING THE *CONTROL PANEL*

70 • The *Control Panel*

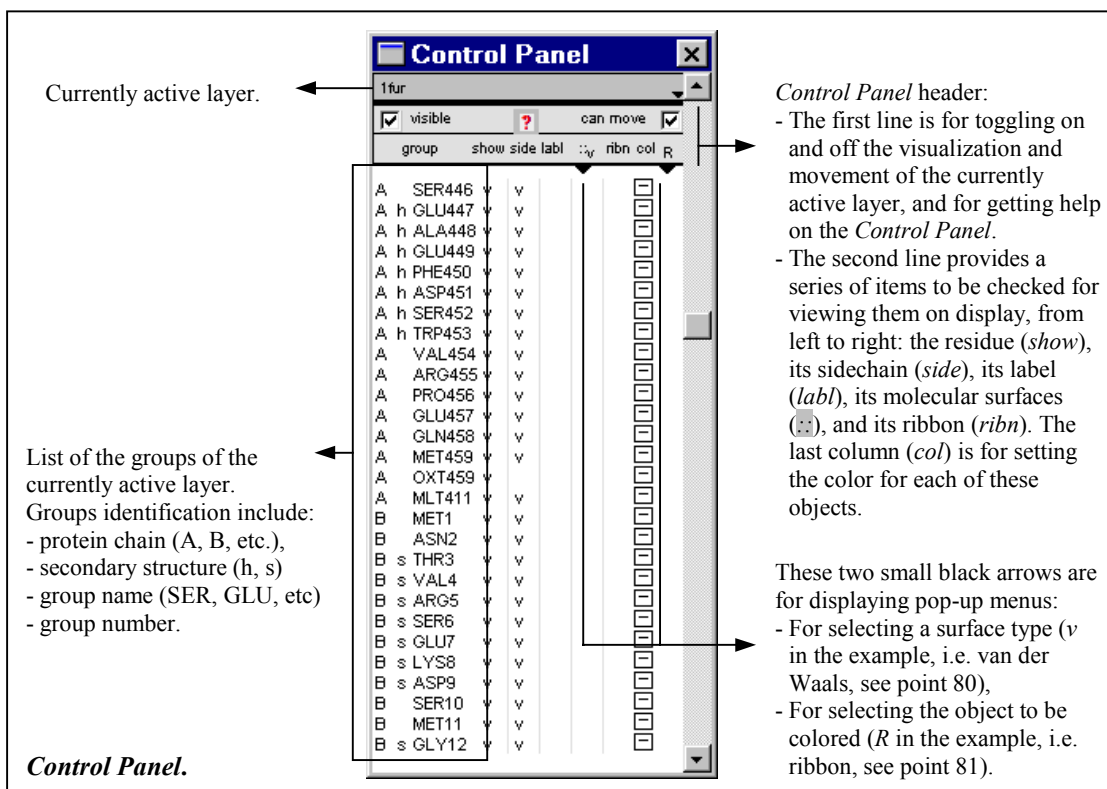

Currently active layer. ← 1fur

Control Panel header:

- The first line is for toggling on and off the visualization and movement of the currently active layer, and for getting help on the *Control Panel*.
- The second line provides a series of items to be checked for viewing them on display, from left to right: the residue (*show*), its sidechain (*side*), its label (*labl*), its molecular surfaces () and its ribbon (*ribn*). The last column (*col*) is for setting the color for each of these objects.

List of the groups of the currently active layer. Groups identification include:

- protein chain (A, B, etc.),
- secondary structure (h, s)
- group name (SER, GLU, etc)
- group number.

These two small black arrows are for displaying pop-up menus:

- For selecting a surface type (v in the example, i.e. van der Waals, see point 80),
- For selecting the object to be colored (R in the example, i.e. ribbon, see point 81).

Control Panel.

group	show	side	labl	ribn	col	R
A	SER446	v	v			
A	h GLU447	v	v			
A	h ALA448	v	v			
A	h GLU449	v	v			
A	h PHE450	v	v			
A	h ASP451	v	v			
A	h SER452	v	v			
A	h TRP453	v	v			
A	VAL454	v	v			
A	ARG455	v	v			
A	PRO456	v	v			
A	GLU457	v	v			
A	GLN458	v	v			
A	MET459	v	v			
A	OXT459	v	v			
A	MLT411	v	v			
B	MET1	v	v			
B	ASN2	v	v			
B	s THR3	v	v			
B	s VAL4	v	v			
B	s ARG5	v	v			
B	s SER6	v	v			
B	s GLU7	v	v			
B	s LYS8	v	v			
B	s ASP9	v	v			
B	SER10	v	v			
B	MET11	v	v			
B	s GLY12	v	v			

71 • Changing the currently active layer

The *Control Panel* governs the currently active layer.

If you are working on a project (i.e., several layers are loaded), click on the gray bar below the *Control Panel* title bar: a pop-up menu with the names of all loaded molecular coordinate files is displayed. Select one file to make it the currently active layer:

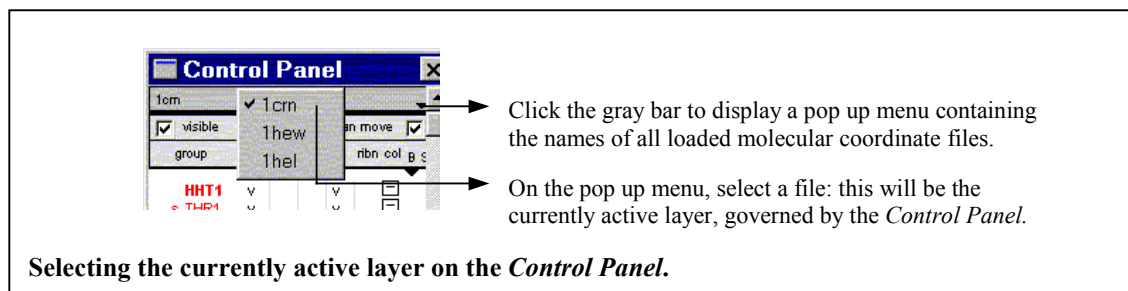

NOTES:

The currently active layer can also be selected on the *Alignment* window (see point 114) and on the *Layers Infos* window (see point 84).

Hitting the Tab key while the *Control Panel* is the active window cycles through all layers.

72 • Centering the model on a specific group

Windows: in the *Control Panel* right-click a group to center the view on its alpha carbon (CA). The group appears in bold in the *Control Panel*. This action is very useful for jumping to a specific group in the model.

Linux, Irix: right Alt + click the residue using any mouse button.

Mac: option-click the group in the *Control Panel*.

73 • Selecting all groups belonging to a chain

The first column under the *group* header is for the protein chains, named A, B, C.... Click anywhere to select all groups (amino-acids + hetero groups) belonging to the selected chain. (If the model contains no chain identifiers, the column is blank and clicking it will select all groups).

74 • Selecting all groups belonging to a secondary structure element

The second column under the *group* header is for the protein secondary structures, named h, s, (-). Click anywhere to select all groups (amino-acids) belonging to the selected secondary structure element.

75 • Selecting one group only

The third column under the *group* header is for the amino-acids identification (VAL1, LEU2... see point 46). Clicking a group will select it.

76 • Selecting several individual groups

In the third column under the *group* header, you can select several individual groups by clicking them while holding down Ctrl on PCs or Alt on Mac, Linux, and Irix.

Alternatively, you can use the numerical keypad (not implemented yet):

enter the first group number and then,
 typing + before the next entered number will add the residue to the selection,
 typing - before the next entered number will deselect the residue to the selection.
 (e.g. 72+85 will select groups 72 and 85. Typing +87 will add group 87 to the selection, whereas typing -72 will deselect group 72).

77 • Selecting an interval of groups

Select an interval of groups by:

clicking the first group and dragging up or down to the last group,
 clicking the first group and pressing Shift while clicking the last group,
 using the numerical keypad (not implemented yet): enter the number of the first group, type slash, and enter the number of the last group (e.g. 72/85 will select groups 72 to 85).

NOTES:

Selected groups appear red in the *Control Panel*, and the total number of selected groups is displayed in the *Layer Infos* window (see point 84).

For further ways to select groups, see points 50-56.

78 • Setting the display of a single group

Check/uncheck the columns after the name of a group to display/hide the following objects:

Column (<i>Control Panel</i>)	Displayed object for amino-acids (<i>Graphic window</i>)	Displayed object for other groups (<i>Graphic window</i>)
<i>show</i>	Backbone (*) The <i>show</i> column has to be checked to enable the display of sidechains, labels and surfaces.	Atom or group of atoms The <i>show</i> column has to be checked to enable the display of all other checked options.
<i>side</i>	Sidechain	(no effect)
<i>ribn</i>	Ribbon	(no effect)
<i>labl</i>	Amino-acid label. See point 60 to select the kind of label.	Group label

NOTE:

(*) In principle, to see the sidechain of a group, its backbone must be displayed. However, see point 57 to see sidechains without backbone.

79 • Setting the display of several selected groups

Once you have selected several groups in the *Control Panel* window, you can:

press *Return* to hide unselected groups on the *Graphic window*,
 set the display of all selected groups at once by checking the *Control Panel* options as it follows:

<u>All platforms</u>	Left-click	Shift-Left-click
Click any point in a column	Checks/unchecks the pointed group	Checks/unchecks all groups
Click the column header	Checks selected (red) groups only	Checks selected (red) groups only

If several layers are opened, you can extend your check to all layers by:

Mac, Windows, Irix: Shift + Ctrl click.

Linux: shift + left Alt click.

80 • Displaying surfaces

DeepView offers three ways to represent a surface:

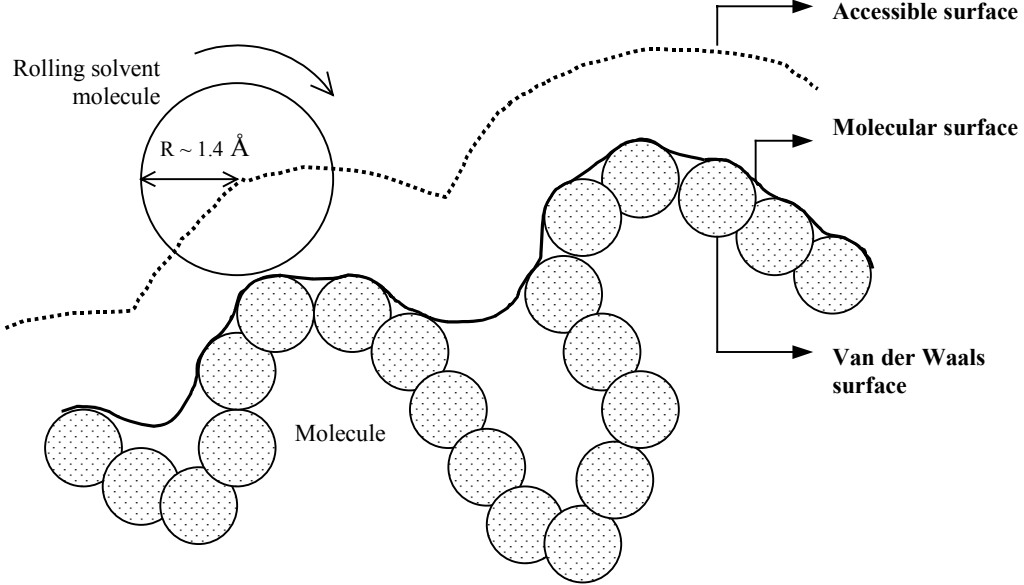

Surface	Definition
Van der Waals	Contact surface of each atom, based on the Van der Waals radius.
Accessible	Surface described by the center position of a water molecule that would be rolled over the protein. This is approximated by rolling a sphere with a 1.4 Å radius, which is approximately the radius of a water molecule.
Molecular	Area that can be reached with the surface of a solvent molecule (1.4 Å) rolled over the protein.

Surface types.

You can display a surface by:

Directly enabling its display on the *Control Panel*: **van der Waals** and **Accessible** surfaces.





Computing it first (see point 102) and enabling its display on the *Control Panel*: **Molecular** surface.

Loading it from a file (see point 22): **any surface**.

Using the *Control Panel* lets you toggle on and off the display of the van der Waals, Accessible and Molecular surfaces assigned to each group, individually:

select a surface in the pop-up menu associated to the surface header (fifth header),

under the surface header, checkmark the groups for which you want to display the selected surface:

<i>Control Panel</i> , surface header		
Header	Surface type	Drawing result
	Van der Waals	A dotted sphere surrounding each atom. The surface will appear as a solid atom when OpenGL Rendering is enabled, or during POV-Ray renderings (see points 140-141). The density of points can be set in <i>Preferences>Display</i> (see point 167).
	Accessible	Equivalent to plotting the van der Waals surface increased by 1.4 Å. The density of points can be set in <i>Preferences>Display</i> (see point 167).
	Molecular	Equivalent to applying a shrink-wrap to the van der Waals surface model. To display a molecular surface, this must first be computed by clicking <i>Tools>Compute Molecular Surface</i> (see point 102). The surface quality and its initial appearance can be modified in <i>Preferences>Surfaces</i> (see point 156)
	User	Not implemented yet.

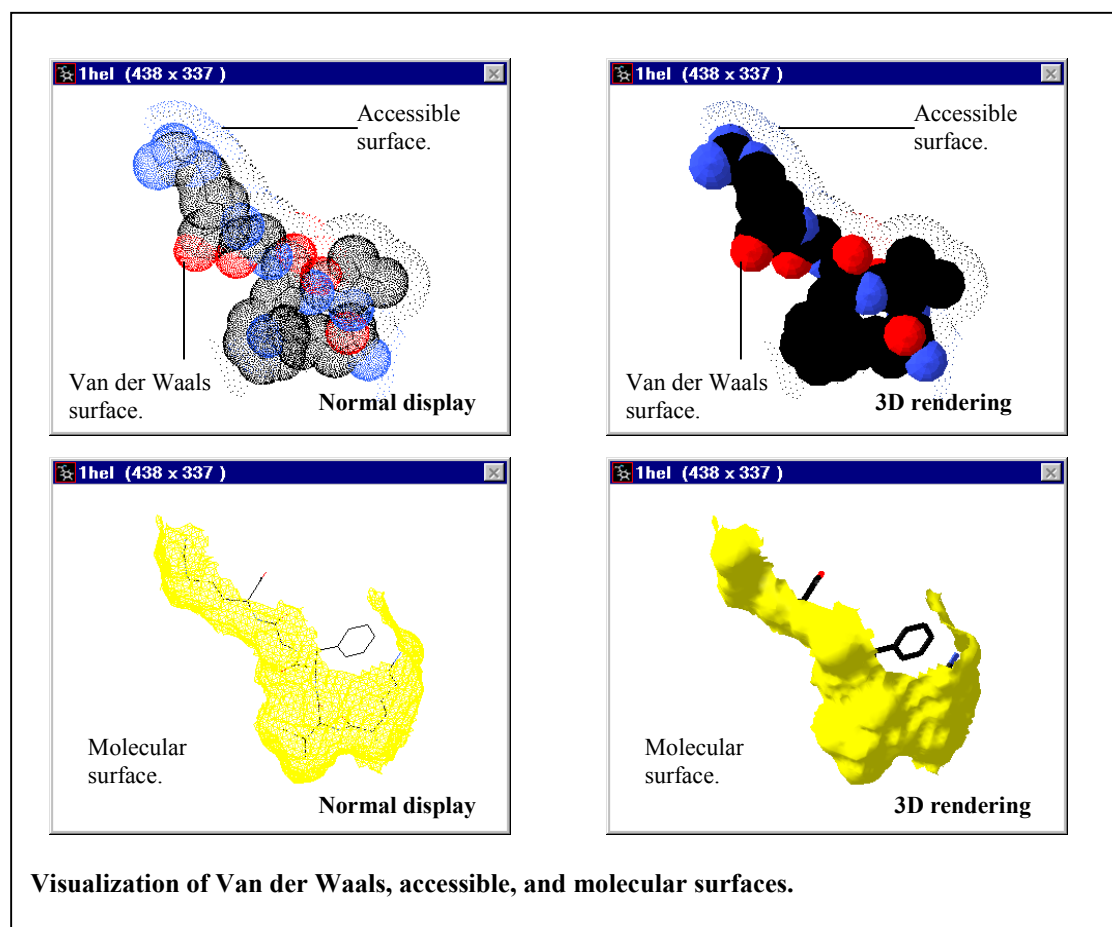

81 • Coloring the molecule

The *col* column of the *Control Panel* allows assigning different colors to the backbone(s), side chains, ribbon(s), labels and surfaces of individual groups:

To select the object to be colored:

In the pop-up menu of the *col* header select the object to be colored (i.e. backbone, side chains, etc.) in the next operation:

Control Panel, color header	
Header	Selected object
<i>Col</i> <i>B S</i>	backbone + side (i.e. backbone + side chains)
<i>Col</i> <i>B</i>	backbone
<i>Col</i> <i>S</i>	side (i.e. sidechains)
<i>Col</i> <i>R</i>	ribbon
<i>Col</i> <i>L</i>	label
<i>Col</i> <i>U</i>	surface: only valid for molecular surfaces, since van der Waals and accessible surfaces will always take the color set for the corresponding atom.

To color the selected object:

in the *col* column select the boxes corresponding to the groups for which you want to color the selected object. You can either drag your mouse to select several boxes in a row, or shift-click anywhere in the column to select all boxes.

a *Color* dialog is displayed, in which you can select a color. To select the CPK colors hit *OK*. Notice that the *Cancel* button does not work: it colors selected residues black. This action can be annulled by selecting *Color>By CPK*.

(For other ways to color a molecule see points 62-66, *Color* menu).

82 • Viewing/moving a layer

The following commands, which are only meaningful when working with projects (see chapter on advanced functions, section B), are located above the column headers of the *Control Panel*. Check them to enable the following actions:

Control Panel, upper header	
Command	Action
<i>visible</i>	Show/hide the whole layer.
<i>can move</i>	Allows moving the layer (i.e., translating and rotating it).

83 • Obtaining help on the Control Panel 

Click on the red question mark to obtain help on the *Control Panel*.

III. USING THE LAYERS INFOS WINDOW**84 • The Layers Infos window**

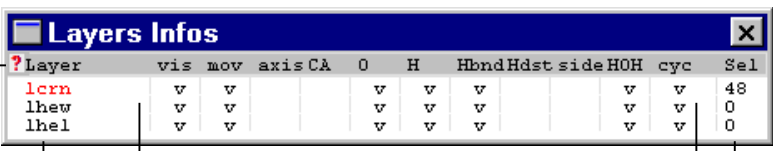

Click the question mark to obtain help on this window.

Layer	vis	mov	axis	CA	O	H	Hbnd	Hdst	side	HOH	cyc	Sel
lcrn	v	v			v	v	v			v	v	48
lhew	v	v			v	v	v			v	v	0
lhel	v	v			v	v	v			v	v	0

↓

List of all loaded files. The currently active layer appears in red. You can select it here.

↓

For each layer, check/uncheck these items to toggle on/off the display or actions described below. Hold down Shift to act on all layers.

↓

Shows the number of currently selected groups in each layer.

Layers Infos window

85 • Setting the display of layers

When several layers are loaded, the *Layers Infos* window lets you independently set the display of each layer by checking/unchecking the following items:

Layers Infos window	
Item	Toggles on and off...
<i>vis</i>	the display of layers
<i>mov</i>	the movement of layers. (For the relative movement of layers see point 113)
<i>axis</i>	the display of the coordinate system axis associated to each layer (see point 113)
<i>CA</i>	the display of the backbone as a Alpha Carbon Trace
<i>O</i>	the display of backbone oxygen atoms
<i>H</i>	the display of hydrogen atoms (if any)
<i>Hbnd</i>	the display of H-bonds (if they have been computed)
<i>Hdst</i>	the display of H-bond distances (if they have been calculated)
<i>Side</i>	the display of sidechains, even when backbone is hidden. This option is automatically checked if the <i>Show Sidechains even when Backbone is Hidden</i> command of the <i>Display</i> menu is enabled
<i>HOH</i>	the display of water molecules (if they were loaded, see point 150, <i>Loading Preferences</i> dialog)
<i>cyc</i>	the cycling of layers, which is achieved with Ctrl+Tab. Cycling through layers displays the next layer enabled to cycle

NOTE:

To affect all layers, hold down the Shift key while selecting an option (valid for all platforms).

86 • Obtaining help on the *Layers Infos* window 



Click the red question mark to obtain help on the *Layers Infos* window.

Advanced DeepView Commands

I. WORKING ON A LAYER

87 • Classification

Advanced commands that can be applied to a single layer can be grouped into four categories:

Category	Command	Action achieved	See point
Modifying commands (modify the structure of molecules)	•  <i>Mutate</i>	Mutates amino acids	88
	•  <i>Torsion</i>	Modifies torsion angles of selected groups (i.e. ϕ , φ , χ_1 ... χ_5 angles)	89
	• <i>Build>Build Loop</i> • <i>Build>Scan Loop Database</i>	Build loops	90
	• <i>Build>Find best Fitting Peptides</i>	Finds segments of sequence in a poly-Ala model, matching electron density maps.	91
	• <i>Build>Break/ Ligate Backbone</i> • <i>Build>Add C-terminal oxygen</i> • <i>Tools>Set Omega/Phi/Psi</i> • <i>Ramachandran Plot window</i>	Modify the backbone (break/ligate it, alter conformational angles, add OXT groups)	92 93
	• <i>Build >Add / Remove</i>	Add/remove structural elements (bonds, hydrogen atoms, H-bonds)	94
	• <i>Tools>Fix Selected Sidechain</i>	Re-orientates sidechains	95
	• <i>Tools>Randomize Selected Groups</i>	Randomly translates all atoms of selected groups	96
	• <i>Edit>Assign Helix/Strand/Coil Type</i> • <i>Tools>Detect Secondary Structure</i>	Alter the visualization of the ribbon secondary structure (*)	97
Searching commands	• <i>Edit>Find Sequence</i> • <i>Edit>Find Next</i>	Search a layer for segments that match a given amino acid sequence	98
	• <i>Edit>Search for PROSITE pattern</i>	Searches a layer for segments that match PROSITE patterns	99
	• <i>Edit>BLAST Selection vs. SwissProt</i> • <i>Edit>BLAST Selection vs. ExPDB</i>	Search protein databases for homologue amino acid sequences	100
Computing commands	• <i>Tools>Compute H-bonds</i>	Computes H-bonds	101
	• <i>Tools>Compute Molecular Surface</i>	Computes molecular surfaces	102
	• <i>Tools>Compute Electrostatic Potential</i>	Computes electrostatic potential maps	103
	• <i>Tools>Triangulate Maps</i>	Triangulates maps	104
	• <i>Tools>Compute Energy (Threading)</i> • <i>Tools>Compute Energy (Force Field)</i>	Compute energy (threading and force field)	105 106
	• <i>Tools>Energy Minimisation</i>	Performs energy minimisations	107
Crystallographic commands	• <i>Tools>Transl. Layer along Unit Cell</i>	Translates a molecule along its unit cell	108
	• <i>Tools>Build Crystallogr. Symmetry</i>	Applies crystallographic symmetries	109
	• <i>Tools>Apply transf. on current layer</i>	Applies a transformation matrix	110
	• <i>File>Open Electron Density Map</i>	Loads and displays electron density maps	111

NOTES:

(*) This action does not actually modify a structure. It just alters its visualization.

Some advanced commands output result text files that can be opened with a text editor and printed.

a. Modifying commands

88 • Mutating amino acids

Concept

Given a molecule, you can mutate an amino acid by first replacing its sidechain, and then browsing a rotamer library (*Rotolib.aa*), which provides the most commonly observed orientations for the new sidechain.

Examples of application

Studying mutations by using DeepView can be very useful to quickly evaluate their putative effects before actually performing them in the lab.

Procedure

To initiate a mutation, click the *Mutate* tool (12th button of the *Toolbar*) and, following the instructions that appear in the message space below, pick the amino acid to be mutated by clicking any of its atoms on the *Graphic* window. A list with the 20 protein amino acids is displayed. Chose a new amino acid in the list: the original sidechain of the selected group will be replaced by the "best" rotamer of the new amino acid. Clicking outside the list or pressing "return" or "enter" will highlight the original amino acid in the list. (For a definition of the "best" rotamer see Annex 4: Mutations).

Once a mutation is done, the number and the score of the displayed rotamer are shown in the message space below the tools. For example, *rotamer: 4/16 score: -1* means that rotamer 4 out of 16 available rotamers is currently on display and scores -1 (see Annex 4: Mutations).

On the *Graphic* window, H-bonds will appear in green and steric hindrances in purple, provided that the group that makes the contact with the mutated amino acid is visible. You can cycle through all available rotamers by hitting the * key of the numerical keypad (holding Shift while hitting the * key will select the previous rotamer instead of the next one), or by clicking the little arrows that appear below the *Mutate* tool:



rotamer 5/9 score: -4

Use these arrows to cycle through the available rotamers.

Number corresponding to the displayed rotamer (5) over the number of available rotamers (9).

This score is for evaluating the rotamer: the best rotamer is the one that totalizes the lowest score.

Mutating an amino acid.

Clicking once again the *Mutate* tool ends a mutation. You will be prompted for accepting or discarding the mutation. Discarding it will restore the original side chain.

NOTES:

The *Mutate* tool is currently limited to amino acids.

The tool was designed not only to mutate a residue, but also to provide alternate rotamer conformations, that can be easily browsed.

Two rotamer libraries are available, *Rotolib1.aa* and *Rotolib2.aa*, located in the *stuff* directory. A copy of *Rotolib1.aa*, named *Rotolib.aa*, is loaded at startup to be used by default.

Rotolib2.aa is a backbone dependent rotamer library []. The score is computed as for *Rotolib1.aa*. In addition, the message space displays the probability (from 0 to 1) of finding the specific rotamer in the secondary structure, for example, *R: 2/5 s: -2 p:0.08 h/h* means that the second rotamer over five scores -2 and has a 0.08 probability to be found in this conformation, where the backbone is an helix.

To use *Rotolib2.aa*, close DeepView, copy *Rotolib2.aa* as *Rotolib.aa*, and restart the program.

89 • Applying torsions

Concept

Given a molecule, you can twist it by modifying:

- the ϕ and ψ conformational angles of the backbone of a selected amino acid,
- the χ_1 to χ_5 dihedral angles of the sidechain of a selected amino acid,
- any rotational bond angle in hetero groups.

Examples of application

Applying torsions can be useful to explore all orientations of a previously mutated amino acid, since the available rotamer library provides only the most commonly observed side chain orientations (see above).

Studying torsions also lets you finely adjust the orientation of side chains during protein modeling.

Procedure

Click the *Torsion* tool (13th button of the *Toolbar*) and, following the instructions appearing in the message space below, pick one atom belonging to the group (amino acid or hetero group) to be twisted.

Acting on amino-acids: A number of little arrows will appear below and at the right of the *Torsion* tool, to let you twist the molecule at the selected residue. While changing the χ_1 - χ_5 angles will only affect the selected side chain, changing the backbone dihedral angles *Phi/Psi* will modify the whole protein arrangement. By default, the C-terminal part of the protein will move. However, you can let move the N-terminal part of the protein by removing the checkmark of the last item of the *Tool* menu (*Move C-term part during Phi/Psi Changes*), or by clicking the small box [C/N] on the upper left corner of the *Ramachandran Plot* window (see point 93).

Use the upper and lower arrows to modify ϕ and ψ , respectively.



From top to bottom, use these arrows to modify χ_1 to χ_5 .

Torsion tool: acting on amino acids.

NOTE:

You can use the keyboard instead of clicking an arrow: any sidechain dihedral angle (χ_1 to χ_5) can be rotated by holding down a key from "1" to "5" while clicking and moving the mouse from left-to right. Key "1" will rotate the CA-CB bond, key "2" the CB-CD bond and so on. Alter ϕ or ψ angles by holding down the "9" or "0" key respectively. This might not work on [Linux](#) and [Irix](#).

Acting on hetero-groups: You will be prompted to pick a second atom belonging to the same group. The first picked atom will define the "fixed point", while the second one will be used to define the rotation axis. All atoms downstream the second one will move around the bond defined by the two atoms you picked.

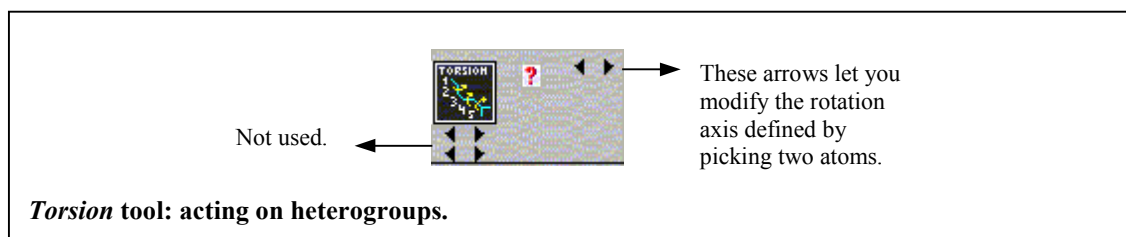

In both cases: A real-time evaluation of clashes and hydrogen bonds is performed, and you might want to enable the display of H-bond length by clicking *Display>Show H-bond distances* to have a numeric feedback. A torsion is ended by clicking once again the *Torsion* tool. You will be prompted for accepting or discarding the torsion. Discarding it will restore the initial position of the group. If you accept the torsion, the amino acid atom names will be updated accordingly to IUPAC nomenclature, if necessary.

90 • Building loops

Concept

DeepView can compute or search a series of loops connecting two amino acid anchor points. These possible loops are evaluated by the number of clashes, by the putative H-bonds that they can make, and by their GROMOS96 Energy.

Examples of application

Building loops might let you complete a protein that has missing parts, refine a protein model returned by Swiss-Model if you are not satisfied with its loops, or search for the best loop during model building. In fact, unlike helices and strands, which are usually well conserved, loops can noticeably vary among similar proteins.

Procedure

Use one of the following commands under the *Build* menu to build a new loop between a pair of amino acids:

Build menu	
Command	Action
<i>Build Loop</i>	Several possible loops will be computed. A result list will be displayed in a <i>Text</i> window (see figure below): - selecting a loop on the list will compute its evaluation parameters and display them on the window, - accept one loop by selecting it on the list and closing the window. <i>NOTE:</i> For large loops involving more than eight amino acids, this command is much slower than <i>Scan Loop Database</i> (see below).
<i>Scan Loop Database</i>	Several loops will be proposed from a database of known loops (<i>_loopDB_</i> , stored in the <i>_stuff_</i> directory). A result list will be displayed in a <i>Text</i> window (see figure below). Accept one loop by selecting it on the list and closing the window.

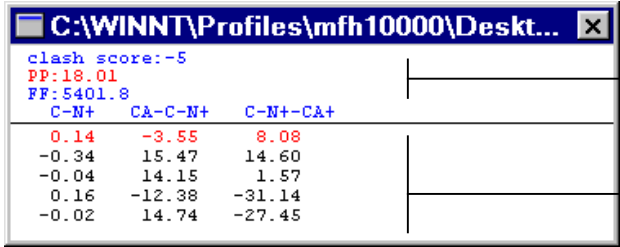

clash score: -5
PP: 18.01
FF: 5401.8

C-N+	CA-C-N+	C-N+-CA+
0.14	-3.55	8.08
-0.34	15.47	14.60
-0.04	14.15	1.57
0.16	-12.38	-31.14
-0.02	14.74	-27.45

(*) For the selected loop on the list, the evaluation parameters give:

- clash score: an evaluation of contacts,
- PP: pair potential (= threading energy, the lower the better),
- FF: force field energy (in kJ, the lower the better).

Build>Build Loop: result list

Evaluation parameters (*): click one to sort the loops below according to that parameter. (It takes a while).

List of computed loops: the first column (C-N+) gives the deviation in Å to the ideal closure bond length, while the next two columns (CA-C-N+ and C-N+-CA+) give the deviation (in degrees) to the ideal angle closure. Selecting a loop will compute and display its evaluation parameters above. Select a loop with the mouse or pressing the up and down keys.

NOTES:

In both cases, once a loop has been selected, it is advisable to perform an energy minimization (see point 107) of the region around the rebuild loop.

For details about clash scores, PP and FF calculations see Annex 4: Mutations.

91 • Matching sequence fragments in poly-Alanin models

Concept

This function tries to match fragments of sequence into a poly-Alanin model according to the fit with a given electron density map.

Examples of application

X-ray derived protein models are built in Electron Density Maps, in several steps. Usually the first step is to identify the secondary structure elements and build them as a generic poly-Ala chain (without sidechains). This provides the initial framework of fragments of the peptide chain. As loops initially are not always visible, these secondary structure elements are often not connected. It is therefore necessary to identify which part of the protein primary sequence might fit in a specific secondary element in order to achieve the construction of the whole peptide chain.

Procedure

To construct a fragment of the peptide chain of a protein, you first need to load the following files:

a poly-Alanin model of the protein chain (molecular coordinate PBD file).

an Electron Density Map of the protein: this might be a *.dn6, *.ccp4, or *.x-plor formatted map.

the amino acid sequence of the protein: this is a text file to be loaded from the *SwissModel* menu (*SwissModel>Load Raw Sequence to Model*) or to be imported from the SwissProt database under the *File* menu (see point 21),

On the *Control Panel*, display the Poly-Alanine file (i.e. this will be the active layer) and select the residues (currently alanines) for which you want to find the real sidechains.

Click *Build>Find Best Fitting Peptides*: DeepView will compute and display a list with the existing polypeptides that would fit onto the backbone fragment that you selected:

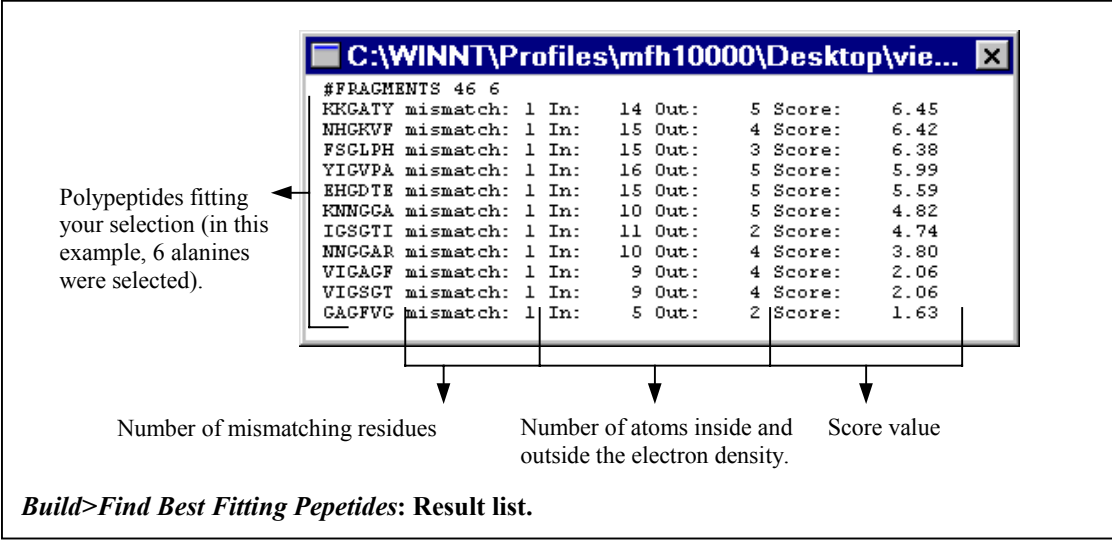

Peptide	mismatch	In	Out	Score
#FRAGMENTS 46 6				
KKGATY	1	14	5	6.45
NHGKVF	1	15	4	6.42
FSGLPH	1	15	3	6.38
YICVPA	1	16	5	5.99
EHGDTB	1	15	5	5.59
KNNGCA	1	10	5	4.82
IGSGTI	1	11	2	4.74
NNCGAR	1	10	4	3.80
VIGACF	1	9	4	2.06
VIGSGT	1	9	4	2.06
CAGFVG	1	5	2	1.63

Build>Find Best Fitting Peptides: Result list.

Results are sorted by a score (see Annex 4: Electron density maps). Explore the various results by either clicking on the different lines, or by using the up and down keyboard arrows while the Result list is the active window. You will visualize the result on the *Graphic* window. On the *Control Panel*, the names of the selected alanines will change into the names of the solution residues.

NOTE:

If the result list window is not active, the up and down keyboard arrows will change the sigma contouring value of the electron density map.

92 • Modifying the backbone

Concept

DeepView lets you modify the backbone by:
 breaking/ligating it at any selected amino acid,
 adding a terminal carboxyl group (OXT),

Examples of application

Since a peptide chain is linked, altering the structural features of a part of a protein (such as modifying the backbone angles of residues) will move all N-terminal residues of the chain. To prevent this, the backbone can be broken after the last residue that belongs to the part of the protein to be altered. This is particularly useful to alter a loop manually: you might want to isolate it from the rest of the protein by breaking the backbone after the last residue belonging to the loop. Once satisfied, you can ligate the backbone again to restore a peptide bond where the backbone was broken.

You might need to add a carboxyl group (OXT) at the end of a chain in order to make the carboxy terminus of a protein after removing residues (see point 94). Note that an OXT is automatically added before any energy calculation (see points 106).

Procedure

To break/ligate the backbone and to add a terminal carboxyl group, use the following commands under the *Build* menu:

Build menu

Command	Action
<i>Break Backbone</i>	You will be asked to pick either a N atom or a C atom of the backbone, which will be broken at this point.
<i>Ligate Backbone</i>	You will be asked to pick an unlinked backbone atom, and DeepView will try to ligate it to the following or previous amino acid, based on distance. Backbone bonds are not made if residues are too far apart.
<i>Add C-terminal oxygen (OXT)</i>	Adds a carboxy terminus for the C-terminal end of the last amino-acid residue in the currently active layer.

93 • Altering conformational angles

Concept

You can alter ϕ , φ , and ω conformational angles of selected residues.

Examples of application

Certain combinations of ϕ and φ are "forbidden" because they result in steric hindrance, or clashes, between atoms. During the last stages of structure determination of proteins, crystallographers use Ramachandran plots to check and rebuild unrealistic conformations in their models.

Procedure

Using the **Ramachandran Plot window**: A Ramachandran plot is a graph of ϕ versus φ . For selected residues of the currently active layer, the *Ramachandran Plot* window displays one small square for glycines and one small plus sign for all other residues. Symbols are colored according to the current backbone color set on the *Control Panel*.

The plot delimits the allowed regions, where most of the amino acids of any given protein should plot:

- in yellow: regions of sterically allowed values of ϕ and φ ,
- in blue: regions of maximum tolerable limits of steric strain

To alter the backbone conformational angles of one residue, click and drag its symbol on the *Ramachandran Plot*. To modify ϕ only, hold down the 9 key while dragging the symbol; to modify φ only, hold down 0 (zero).

Ramachandran Plot window.

Using the *Tools* menu: For selected residues on the *Control Panel* window, the *Set Omega/Phi/Psi* command under the *Tools* menu offers a submenu that allows altering the values of backbone conformational angles:

Tools>Set Omega/Phi/Psi command	
Subcommand	Action

<i>Alpha Helix</i>	Rebuilds selected amino acids as one long alpha helix ($\phi = 60^\circ$, $\psi = 40^\circ$). The helix is not perfectly straight since only ϕ and ψ angles are modified, whereas bond lengths and ω - angles of the backbone are not altered.
<i>Beta Sheet</i>	Rebuilds selected residues in beta conformation ($\phi = 120^\circ$, $\psi = 120^\circ$). Only ϕ and ψ angles are modified, bond lengths and ω - angles of the backbone are not altered.
<i>Other</i>	A dialog allows setting numerical ϕ , ψ and ω values for selected amino acids (i.e. for one or many residues at once). Setting ϕ and ψ to 180 degrees shows the backbone in its most extended form.

By default, the N-terminal part of the protein will stay static, while the C-terminal part will move according to the applied change in the backbone angles. However, you can choose to let move the N-terminal part of the protein by removing the checkmark of the last item of the *Tool* menu (*Move C-term part during Phi/Psi Changes*), or by clicking the small box [C/N] on the upper left corner of the *Ramachandran Plot* window

NOTE:

To make backbone torsional changes that affect only a part of a protein, the part to be altered can be disconnected from the rest of the protein (*Build>Break Backbone*), and then reconnected afterwards (*Build>Ligate Backbone*).

94 • Adding/removing residues, bonds, and atoms

Concept

DeepView offers several commands that allow adding or removing residues, bonds, H-bonds, hydrogen atoms, and water molecules.

Examples of application

These commands are useful to fine-tune an image before a final rendering (e.g. by adding or removing H-bonds), or to discard a part of a protein to save truncated proteins (e.g. by removing one chain). The inverse operation, which consists of creating new entities by merging layers, is developed in point 115).

Procedure

Under the *Build* menu select a command to achieve one of the following actions:

Build menu, Add commands	
Command	Action
<i>Add Residue</i>	Pick a N or a C terminal atom. A list with the 20 protein amino acids is displayed: select one residue. This will be added as a terminal residue. This command also lets you insert residues in the protein.
<i>Add Bond</i>	This will add a bond from or within a HETATM. You will be prompted for two atoms to be bonded, the first one must belong to a HETATM. This function can be useful when no CONECT information is present in a PDB file, as the automatic connection feature is not guaranteed to be able to figure out all connections (see note below and Annex 4:). Extra connections will be saved with the file.
<i>Add H-Bond</i>	This will let you pick two atoms to manually add an H-bond in between them. Note that these manually added bonds are not saved in the PDB file, and will be lost anytime you re-compute the H-bonds. (Useful for final polish of a scene, when the <i>Tools>Compute H-bonds</i> command has missed the very special H-bond you wanted to render, see point 101).
<i>Add Hydrogens</i>	Adds missing polar hydrogen atoms, according to GROMOS96 topology. X-ray derived structures normally do not contain hydrogen positions. Warning: applying this function currently rebuilds all H-atoms of the layer.
<i>Add H2O</i>	A water molecule will be added at 2.6 Å of the picked atom, in a location where it does not clash too much and where it is able to do H-bonds. (Useful to add water molecules to a structure and to evaluate their position).

Build menu, Remove commands

Command	Action
<i>Remove Selected residues</i>	Deletes selected residues.
<i>Remove Bond</i>	Removes a bond added to a HETATM. You will be prompted for the two bonded atoms, the first one must belong to the HETATM (see note below).
<i>Remove H-Bond</i>	Removes an added H-Bond, which you will be prompted for by selecting the two bonded atoms.
<i>Remove Hydrogens (All)</i>	Removes all hydrogens from the currently active layer. This will not apply to HETATM groups unless you hold the Ctrl key while invoking this command. (You might need to remove H since DeepView may occasionally miss-identify non-hydrogen atoms as hydrogens, depending on how the individual atoms have been named, which is sometimes done incorrectly for two-letters element abbreviations, i.e. He, Hf, Hg, and Ho might look like hydrogens).
<i>Remove Hydrogens (Non Polar)</i>	Same as before, but only for non-polar H. This produces cleaner pictures of NMR structures, for example..

NOTE:

Add bond and *Remove bond* functions were designed to modify the connections of:

heterogroups wrongly connected in some PDB files,

heterogroups badly connected by the automatic reconnection algorithm that DeepView uses when no CONECT cards are present in PDB files.

95 • Re-orientating sidechains

Concept

Given a molecule, you can select all sidechains of a specific spatial area and explore all rotamers to see which is the best combination.

Examples of application

When modeling a protein structure, you can study the different sidechain orientations and optimize them in order to make good contacts. If this cannot be achieved, it could reflect a misalignment between the protein to be modeled and the template.

When studying mutations, you can see if a specific residue has a chance to fit well in the structure, according to its different sidechain orientations.

Procedure

Select the residues whose sidechain need to be re-orientated. Click *Tools>Fix Selected Sidechains*: a submenu allows finding the best rotamers according to the three following techniques:

<i>Tools>Fix Selected Sidechains</i> command	
Subcommand	Action
<i>Quick and Dirty</i>	Finds the best direct fit from the rotamer library. This often provides a reasonable fit, since most residues have a limited number of preferred conformations.
<i>Exhaustive Search</i>	This routine will try to test all reasonable combinations of dihedral angles along the sidechain, to find the best fit. You cannot select more than 10 amino acids.
<i>Simulated Annealing</i> (Not available yet)	This method is the most thorough. It tries to minimize the energy computed as a combination of GROMOS96 energy and mutation score (H-bonds and clashes).

NOTE:

The quality of fit is determined according to the formula given in Annex 4: Mutations.

96 • Randomly translating all atoms of selected groups

Concept

With pedagogic purposes, DeepView offers a command that lets you randomly translate all atoms of selected groups.

Examples of application

You can alter the position of all atoms of a molecule in order to see the effects of an RMS computation or an energy minimization.

Procedure

Click *Tools>Randomize Selected Groups* to randomly translate all atoms of selected groups on the *Control Panel*. You will be prompted for the translation distance, to be entered in Å. The RMSd (Root Mean Squared deviation) between the original coordinates and the altered ones will be equal to this value.

97 • Altering the visualization of the ribbon secondary structure

Concept

When a protein is loaded, its secondary structure is automatically computed (see Annex 4: Secondary structure detection). This computation might misinterpret the secondary structure in ambiguous regions, or whenever one residue can be considered as belonging to two secondary structure elements at the same time. The net result is that the ribbon (drawn accordingly to the method of Carson, 1987) does not look as nice as it could. A set of commands allows altering the ribbon visualization, to help making nicer images. These commands do not actually modify the structure of molecules, and will only affect the rendering (note that these modifications are not saved in DeepView files and are lost when *Tools>Detect Secondary Structure* is applied).

Examples of application

You can try to improve a protein image. For example, if a strand is directly followed by a helix, and an arrow is put at the end of the strand (this depends on your ribbon preferences, see point 155), it might happen that the arrow is not complete because the last strand residue is assigned to the helix. To make a nicer image, select the last strand residue (or the first helix residue), and set it as a coil residue.

Procedure

On the *Control Panel*, select the residues to be transformed, enable their ribbon visualization on the *Graphic* window, and then do one of the following:

Under the *Edit* menu select a command to achieve one of the following actions:

<i>Edit</i> menu	
Command	Action
<i>Assign Helix-Type to Selected aa</i>	Selected residues are displayed as α -helix.
<i>Assign Strand-Type to Selected aa</i>	Selected residues are displayed as β -strand.
<i>Assign Coil-Type to Selected aa</i>	Selected residues are displayed as random-coil.

Click *Tools>Detect Secondary Structure* to reset the display to the originally computed secondary structure of the currently active layer.

b. Searching commands

98 • Searching a molecule for a sequence pattern

Concept

Given a molecule, its sequence is searched for the occurrence of a specific fragment of amino acids (or for a PROSITE pattern), that you can enter on the *Find Sequence / PROSITE pattern* dialog:

Examples of application

You can look for specific sites such as active sites, glycosylation sites, etc. This might be useful to compare the conformation of a specific motif in different structures to draw conclusions about its function.

Procedure

Click *Edit>Find Sequence*: the *Find Sequence / PROSITE pattern* dialog is displayed to let you enter a sequence of amino acids or a PROSITE pattern:

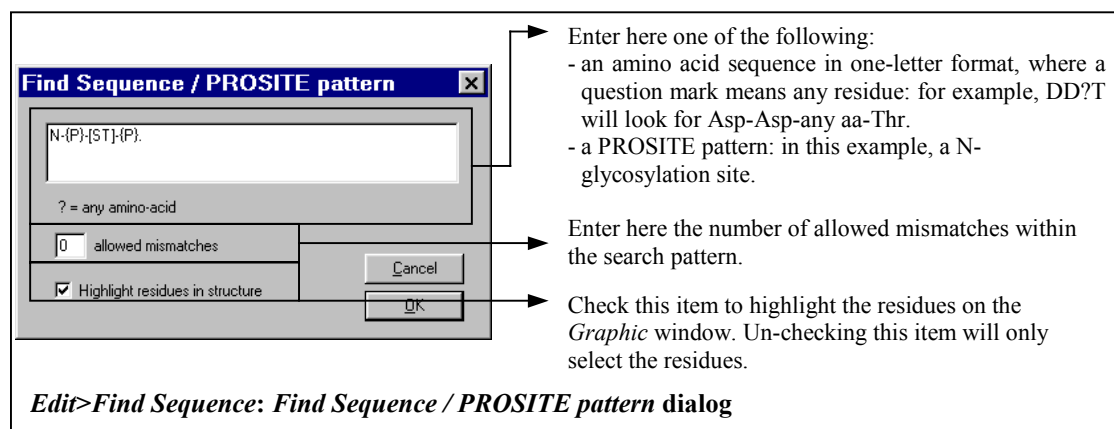

DeepView will then look for this sequence in the currently active layer. If the sequence is found, this will be selected in the *Control Pane*

Click *Edit>Find Next* to find the next sequence of the currently active layer that matches your entered sequence.

NOTE: The current settings for allowed mismatches will also apply for other search functions, e.g. "Search for Prosite Patterns".

99 • Searching a molecule for all patterns in the PROSITE database

Concept

The currently active layer is searched for PROSITE patterns that match any fragment of the amino acid sequence.

Examples of application

In homology modeling, finding identical PROSITE patterns in the target and the template sequences helps refining their manual alignment (see point 132).

Procedure

Select *Edit>Search for PROSITE pattern*: DeepView looks for the occurrence of all specific PROSITE patterns. An interactive result list is displayed (see figure below).

NOTE:

PROSITE patterns are defined in the *prosite.dat* file, which contains a set of amino acid patterns that define certain features of proteins (e.g. glycosylation sites, etc): you need to have downloaded the latest version of *prosite.dat*, from <http://www.expasy.org/prosite>, and placed it into your *usrstuff* directory.

PROSITE accession codes: click an AC to import a text file containing detailed information on the pattern.

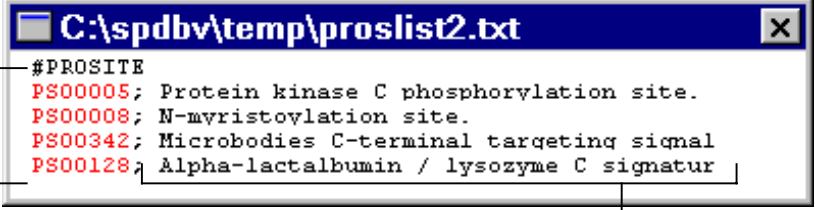

Edit>Search for PROSITE pattern: result list.

Pattern description: click a pattern to highlight it on the structure according to the settings entered in the *Find Sequence / PROSITE* pattern dialog (see point 98).

100 • Searching SWISS-PROT and ExPDB databases

Concept

You can use the DeepView server to search SWISS-PROT and ExPDB databases for amino acid sequences similar to a previously selected fragment of amino acids in the currently active layer.

Examples of application

Given a molecule, you can find other proteins with a similar sequence, for modeling purposes.

Procedure

Under the *Edit* menu, select one of the following commands:

<i>Edit</i> menu	
Command	Action
<i>BLAST selection vs. SwissProt</i>	You first need to select a fragment of at least 10 amino acids. The DeepView server uses BLAST (Altschul, 1990) to search SwissProt and TrEMBL for proteins containing a fragment of amino acids similar to your selection. A result text file named <i>blast.txt</i> (see figure below) is sent back and stored in your <i>download</i> directory.
<i>BLAST selection vs. ExPDB</i>	Doing successive <i>BLAST</i> selections will generate new <i>blast.txt</i> files, which will be named <i>blast2.txt</i> , <i>blast3.txt</i> , etc. These text files contain red hyperlinks that let you import BLAST hits for further comparisons.

Depending on the selected command, one the following result lists is displayed.

Reference: Altschul, Stephen F., Thomas L. Madden, Alejandro A. Schaffer, Jinchui Zhang, Zheng Zhang, Webb Miller, and David J. Lipman (1997), "Gapped BLAST and PSI-BLAST: a new generation of protein database search programs", *Nucleic Acids Res.* 25:3389-3402.

Query= query
(23 letters)

Database: sp
88,753 sequences; 32,291,714 total letters

Searching.....done

Sequences producing significant alignments:

	Score (bits)	E Value
HBB HVLLA (P02025) HEMOGLOBIN BETA CHAIN	51	3e-07
HBB GORGO (P02024) HEMOGLOBIN BETA CHAIN	51	3e-07
HBB HUMAN (P02023) HEMOGLOBIN BETA CHAIN	51	3e-07
HBB PREEN (P02032) HEMOGLOBIN BETA CHAIN	50	6e-07

Annotations:
 - Number of selected aa for the query (23).
 - Searched database: sp (= SwissProt).
 - Protein description
 - SwissProt identifier
 - SwissProt accession codes: clicking an AC imports the corresponding SwissProt entry as a text file.
 - BLAST scores (see Altschul, 1990).

Edit>BLAST selection vs. SwissProt: result list.

Reference: Altschul, Stephen F., Thomas L. Madden, Alejandro A. Schaffer, Jinchui Zhang, Zheng Zhang, Webb Miller, and David J. Lipman (1997), "Gapped BLAST and PSI-BLAST: a new generation of protein database search programs", *Nucleic Acids Res.* 25:3389-3402.

Query= query
(25 letters)

Database: ExNRL
22,869 sequences; 5,126,101 total letters

Searching.....done

Sequences producing significant alignments:

	Score (bits)	E Value
ExNRL: 7LYZ .pdb	60	1e-10
ExNRL: 6LYZ .pdb	60	1e-10
ExNRL: 6LYT .pdb	60	1e-10
ExNRL: 6LYZ .pdb	60	1e-10

Annotations:
 - Number of selected aa for the query (25).
 - Searched database: ExNRL (= ExPDB).
 - PDB accession code: clicking an AC will import the PDB file into Deep View.
 - BLAST scores (see Altschul, 1990).

Edit>BLAST selection vs. ExPDB: result list.

NOTE: These functions require network access, the DeepView Network Preferences must be set correctly.

c. Computing commands

101 • Computing H-bonds

Concept

H-bonds are computed on the basis of atom distances, atom angle, and atom types. This computation is used to give an indication of putative H-bonds, over-prediction being desirable for visual feedback. Therefore, even when hydrogen atoms are not explicitly present, putative H-bonds are drawn between H-Donor and H-Acceptor atoms.

Distance constraints: H-bonds are drawn if a hydrogen atom is within a distance ranging between 1.2 and 2.76 Å of a "compatible" H-Acceptor atom. When hydrogen atoms are absent, H-bonds are drawn between H-Donor and H-Acceptor atoms if the distance H-Donor---H-Acceptor is comprised between 2.35 and 3.2 Å. H-bonds within this distance range are drawn as green dotted lines, weaker H-bonds (extra allowed distance: +0.05 Å, by default) appear in gray. When a group is at an H-bond distance of several other atoms, all possible H-bonds are drawn, with no attempt to choose the best one. Distance settings can be modified in the *H-bonds detection threshold* dialog (see point 160, *Preferences* menu).

Angle constraints: when hydrogen atoms are present, H-bonds are drawn if the angle H-Donor---H atom---H-Acceptor is superior or equal to 120°. When hydrogen atoms are absent, it is not possible to compute this angle, and H-bonds are drawn between a H-Donor and an H-Acceptor atoms if the angle PreviousAtom---H-Donor---H-Acceptor or H-Donor---H-Acceptor---NextAtom is superior or equal to 90°.

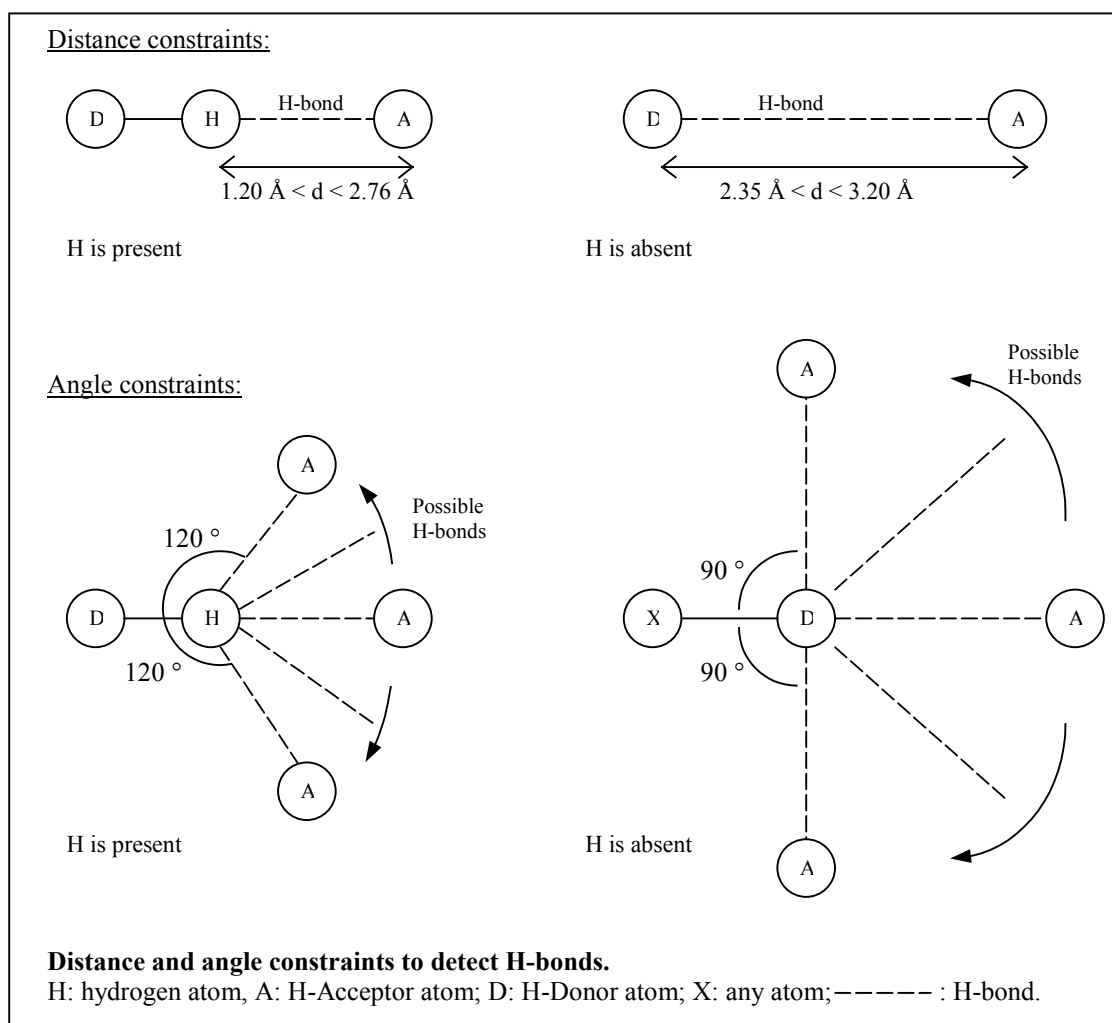

Examples of application

Computing H-bonds lets you visualize polar interactions in the protein. When modeling structures, this might be useful to properly place side chains, i.e. making a maximum number of H-bonds and a minimum number of clashes.

Procedure

Click *Tools>Compute H-Bonds*. These will be automatically drawn on the *Graphic* window, according to the distance and angles constraints given above.

NOTE:

Certain atoms can behave as H-Donors or as H-Acceptors, depending on certain conditions. Therefore, when hydrogen atoms are not explicitly present, it might be possible to find erroneous predictions of H-bonds computed between two H-Donors or between two H-Acceptors. These erroneous H-bonds can be removed by clicking *Build>Remove H-bond*.

102 • Computing molecular surfaces**Concept**

For a given a protein, DeepView can compute and display its molecular surface, which is defined as the area that can be reached with the **surface** of a solvent molecule (radius = 1.4 Å) that is rolled over the protein (see point 80). The drawing result is equivalent to applying a shrink-wrap to the van der Waals surface.

Examples of application

Building molecular surfaces allows visualizing the shape of a protein and its surface properties

Procedure

Tools>Compute Molecular Surface will compute a molecular surface using a numerical grid algorithm.

Surfaces can also be loaded in three different file formats:

- saved from a previous DeepView session (*.sfc),
- written by the program MSMS (Sanner & Olson, 1996)
- written by the program GRASP (Honig et al. 1991).

Molecular surfaces can be colored in a similar manner as all other graphical objects:

First select *act on Surface* in the *Color* menu (see point 62) or in the *Control Panel* header (see point 81).

Then select any of the coloring functions in the color menu or use the control panel to assign specific colors.

The default appearance of a molecular surface is defined in the *Surface preferences* dialog (see point 156), which offers three different surface colors, by *Cavity*, *Atom Type* or *Electrostatic Potential*:

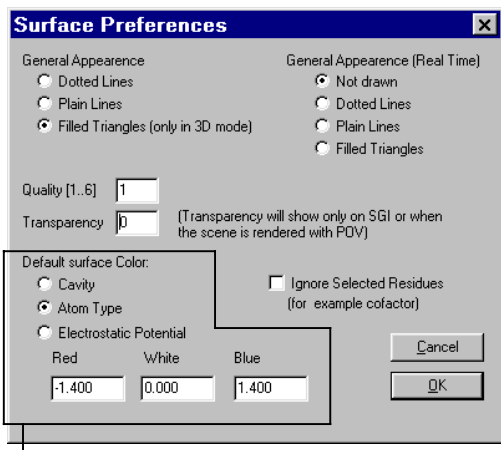

The *Surface Preferences* dialog offers three default surface colors:

- *Cavity*: the molecular surface is colored in yellow, and different colors are assigned to the cavities inside the protein.
- *Atom Type*: the surface is assigned the CPK colors of underlying atoms,
- *Electrostatic Potential*: a color gradient from blue to white to red is used to color the molecular surface, where blue, red, and white are for positive, negative, and neutral potentials, respectively, according to the given cutoff values (in kT/e). Note that to apply these colors you first need to compute the electrostatic potential (see point 103).

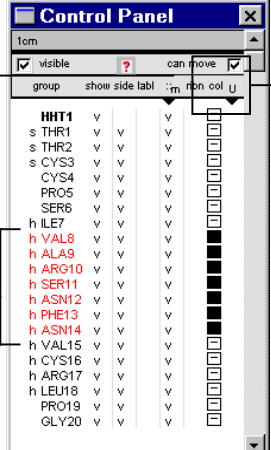

Use the *Control Panel* to assign colors of your own choice to a computed molecular surface:

- 1- on the *surface* header, select *molecular surface*,
- 2- select the groups for which you want to color the surface,
- 3- on the color header, select to color surfaces, and then click *col* to display the color palette where you can choose a color.

Coloring a molecular surface by using the surface preferences and the *Control Panel*.

Computing a molecular surface allows identifying internal cavities big enough for a water molecule: on the *Surface Preferences* dialog (see point 156), select the *Cavity Default surface Color*, compute the molecular surface, display the *Surface and Cavities* window:

- The first line is for the molecular surface.
- Remaining lines are for detected cavities, listed by decreasing size: click a line to center the view on the corresponding cavity; Shift+Ctrl click a line to center and display only the residues surrounding the cavity.

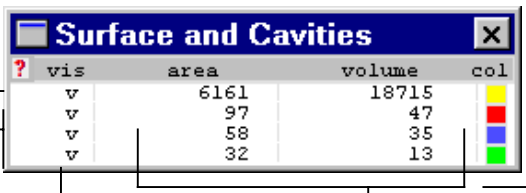

Check here to display on the *Graphic* window the molecular surface and the detected cavities.

Surface (Å²) and volume (Å³) of the molecular surface and detected cavities.

Colors assigned to the molecular surface and to the detected cavities. Click a box to change the color.

Window>Surface and Cavities window.

Before you compute a molecular surface, its drawing quality can be set on the *Surface Preferences* dialog by entering a value from 1 (worst quality) to 6 (best quality). This is important because areas and volumes of cavities depend on the drawing quality:

Drawing quality	Grid size
1-2	1.40 Å
3-4	0.70 Å
5-6	0.47 Å

NOTE:

Differences in the drawing quality between levels 1-2, 3-4, and 5-6 depends on the number of triangles considered. The **accuracy** of the surface and volume computation, as well as the cavity detection are also dependent on this value.

103 • Computing electrostatic potential maps

Concept

Protein molecules contain charged groups (e.g. side chains and terminal residues) that induce an electrostatic field around the molecule. These potentials can be represented as three-dimensional electrostatic potential maps. DeepView provides two different representations of electrostatic potential maps:

three-dimensional potential maps showing the electric field spreading out into the solvent. A positive value (in kT/e) is used as a cutoff to delimit a blue contour of those grid points whose value is higher than the given cutoff. Similarly, a negative cutoff (in kT/e) is used to delimit a red contour lower than the given cutoff.

distribution of the electric charge at the molecular surface: the molecular surface is colored with a red (negative cutoff), to white (neutral points), to blue (positive cutoff) color gradient.

Examples of application

Comparing the electric field extending into the solvent for different proteins will let you compare their relative ability to attract or repulse other molecules [Klapper *et al.*, 1986]. Displaying the distribution of the electric charge at the molecular surface allows studying protein-protein or protein-substrate interactions.

Procedure

Tools>Compute Electrostatic Potential: the *Electrostatic Potential* dialog is displayed, where you can set several computing options:

For setting the *Parameters* and *Computation Method* see point 157.

- Check *Keep Map* to display the electric field spreading out into the solvent, see below for further manipulations.
- Check *Map Potential to Surface* to display the electric charge of the molecular surface. Notice that you must have computed a molecular surface first.
- Enter here the cutoff values of the electric charge (in kT/e) to set the color gradient, in this example:
 $-1.6 \text{ kT/e} < 0.0 \text{ kT/e} < 1.6 \text{ kT/e}$
 red → white → blue
 (these values can also be set on the *Surface Preferences* dialog, see above).

Electrostatic Potential dialog for setting the options for computing electrostatic potentials.

Electrostatic potential maps can also be loaded in two different file formats:

- maps computed and saved from a previous DeepView session (*.sph),
- maps computed by external programs, such as GRASP or DELPHI (*.phi), [Nicholls *et al.* 1991]

Once an electrostatic potential map is computed or loaded, you can visualize it around the molecule on the *Graphic* window, and set its display on the *Electron Density Map Parameters* dialog and on the *EDM Infos* window. The sigma value of the *Electron Density Map Parameters* dialog is used to set the kT/e cutoff.

NOTE:

We are aware that setting electrostatic potentials under electron density maps preferences is not very coherent. But both electrostatic potentials and electron density maps are grid-based, and it was faster to implement it this way. A specific dialog for setting electrostatic potentials will be provided in the future.

The contouring value of the first contour in the *EDM Infos* window is displayed on the *Toolbar* (e.g. 0.80 kT/e).

- Red contour: comprises points with kT/e values lower than the cutoff (i.e. $< -0.80 \text{ kT/e}$).
- Blue contour: comprises points with kT/e values higher than the cutoff (i.e. $> +0.80 \text{ kT/e}$).

Put the cursor on the *Graphic* window: Using the up and down keys of the keyboard will increase or decrease both contouring values and refresh the display of the contours in real time.

Visualizing electrostatic potentials.

Electron Density Map Parameters

Infos

	X	Y	Z
Unit Cell Size (Å)	118.000	102.000	108.000
Cell Angles	90.000	90.000	90.000
Nb Sections	60	52	55
Min Section	22	17	23
Max Section	37	34	31

Display

From Section

From Section	22	-17	-23
to Section	37	34	31

Around CA

CA	40.000	40.000	40.000
----	--------	--------	--------

Display only around Selected Residues (slow!)

Contouring

<input checked="" type="checkbox"/> Contour a	3.300	sigma with	Color	<input checked="" type="checkbox"/> Dotted
<input checked="" type="checkbox"/> Contour a	-3.300	sigma with	Color	<input checked="" type="checkbox"/> Dotted

Coarse Contouring Along

X Y Z

Draw Unit Cell

Cancel OK

EDM Infos

? EDM	vis	dot	sigma	corX	corY	corZ	cell	co.
la3od.pot	v	v	3.300					
	v	v	-3.300					

1 4 2 5 6 3

1- Check these items to display the contours.
 2- Edit here the contouring values,
 3- Assign a color to each contour (a blue positive contour and a red negative contour are given by default).
 4- Check these items to display dotted contours (plained lines will be used otherwise),
 5- Check these items for a coarse drawing along the x, y, and z axis (this will worsen the visualization of contours but will refresh them faster whenever the molecule is moved),
 6- Check this item to display the unit cell (not relevant for electrostatic potentials).
 (For all other options of the *Electron Density Map Parameters* dialog, see point 158).

Setting the display of electrostatic potential maps.

104 • Triangulating maps

Concept

Since contours for both electrostatic potential maps (see point 103) and electron density maps (see point 111) are drawn as plain lines or dotted lines, it is not possible to draw them as solid or transparent surface contours, unless they are first triangulated, i.e. converted into surfaces.

Examples of application

Maps are triangulated mostly to obtain nicer pictures when using POV-Ray or OpenGL. Note that their real time display will be faster but that, in counterpart, you will lose the possibility to alter the contouring values.

Procedure

Tools>Triangulate Map: the current contours of an electron density map or an electrostatic potential map are transformed into a surface:

NOTE:

Currently, each layer can have only one surface object. This means that two layers are needed to display a molecular surface and a triangulated map at the same time.

105 • Computing pseudo energy: mean force potential (also pair potential, threading energy, or PP)

Concept

A mean force potential of each residue of the currently active layer is computed (for details on calculations see annex 4). Computed PP values can be plotted against the amino acid sequence.

Examples of application

When modeling structures, a plot of PP versus the amino acid sequence lets you quickly visualize which region of the alignment might be wrong (PP values above zero indicate that this arrangement is not observed in the set of protein structures that was used for the training of the PP).

Procedure

Tools>Compute Energy (Threading): the mean force potential of each residue is computed. Click *Window>Alignment* to open the *Alignment* window, and display its associated graph by clicking on the small arrow next to the red question mark:

Click the small arrow to display the PP or the FF diagrams of the currently active layer.



↓

- layer name, and total molecular PP,
 - click *smooth* to select the number of previous and following aa whose PP will be averaged for smoothing the curve,
 - click *default PP* to switch from this graph to the FF graph.

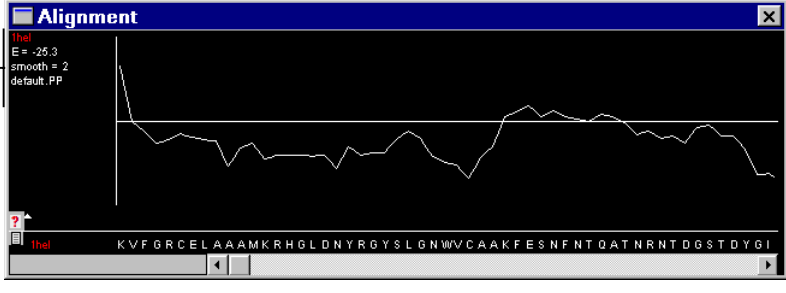

↓

The horizontal line is for PP=0: points lying above correspond to amino acids surrounded by an arrangement of residues not frequently observed in the set that was used to derive the potential.

Tools>Compute Energy (Threading): threading energy vs. amino acid sequence.

106 • Computing energy: force field (also FF)

Concept

An empirical force field energy of each residue of the currently active layer is computed using a partial implementation of the GROMOS96 force field. Computed FF values can be plotted against the amino acid sequence and, on the *Graphic* window, the resulting force at each atom can be displayed.

Examples of application

Both displaying the resulting force at each atom, and plotting the FF vs. the amino acid sequence, will let you quickly visualize parts of the structure with incorrect geometry or too close contacts.

Procedure

Tools>Compute Energy (Force Field): a dialog appears in which you can include or exclude following parameters for FF calculations: bond lengths, torsion energies, bond angles, improper angles, interactions between non-bonded atoms, and electrostatic interactions. On the same dialog, check *Show Energy Report* to display a text file presenting the details of computed FF at each amino acid. (Once a report has been requested, this is stored in the *temp* directory and can be re-opened later by clicking *File>Open Text File*. Note that the content of the *temp* directory is deleted when the DeepView session is closed.).

NOTE:

Force fields are parameterized using all parameters. Therefore, disabling computation of some parameters is an heresy and, although mostly used for didactic considerations, it is not encouraged. However, it might be useful to check and highlight residues on the basis of their bond length and angle deviation only (neglecting non-bonded and electrostatic interactions), or to quickly regularize the geometry of very distorted residues before performing an energy minimisation with all parameters enabled.

/ residue	bonds	angles	torsion	improper	nonBonded	electrostatic	constraint	//	TOTAL
HHT D 1	0.000	6.183	7.540	0.000	0.00	17.35	0.0000	// E=	31.072
HISA D 2	221.420	27.109	12.626	9.528	-22.41	109.21	0.0000	// E=	357.488
LEU D 3	3.262	5.523	10.310	2.653	-43.23	17.87	0.0000	// E=	-3.617
THR D 4	1.828	5.859	3.614	3.765	-6.99	-6.35	0.0000	// E=	1.732

Amino acids list (name, chain ID, number).
 FF (in kJ/mol) computed for each considered object.
 Total FF (in KJ/mol).

Tools>Compute Energy (Force Field): Energy Report.

The Energy Report, like any other text file, can be opened with a text editor and printed.

To display the force graph, Click *Window>Alignment* to open the *Alignment* window, and click its small arrow next to the red question mark:

- layer name, and total molecular FF,
- *Smooth=1* means that the energy of each residue will be the average of itself plus the energy of 1 flanking residue on each side. Click *smooth* to edit the number of flanking amino acids to be considered,
- click *Force Field* to toggle from this graph to the PP graph.

The horizontal line is for FF=0 kJ/mol: points lying above correspond to amino acids in un-favored geometries.

Tools>Compute Energy (Force Field): Force Field vs. amino acid sequence.

To display on the *Graphic* window the resulting force at each atom, click *Display>Show Forces*. These will appear as dotted segments in the direction of the force, colored in a gradient:

0 Kj/mol < 2500 Kj/mol < 5000 or more Kj/mol
 dark blue → green → red

107 • Computing energy minimisation

Concept

Forces acting on each atom of selected groups are minimized by iterative force field calculations followed by structural adjustments.

Examples of application

Whenever a protein is distorted (for example, after applying mutations or torsions, or after reconstructing loops), computing an energy minimisation can repair distorted geometries by moving atoms to release internal constraints.

Procedure

First of all, click *Preferences>Energy Minimisation*: a dialog lets you adjust the minimisation parameters (see point 159):

Energy Minimisation Preferences dialog.

- Enable one, two, or three cycles of n steps of Steepest Descent (currently the only available energy minimization method).
- Checkmark the interactions to be considered.
- *Cutoff*: enter a distance (Å) over which non-bonded and electrostatic interactions will not be considered.
- *Show Energy Report*: check this item to obtain an energy report (see point 106).
- Enter a value to stop minimization when the checked option is verified (in addition to the default stop after completion of the selected number of cycles).
- Select between:
 - *Lock non-selected residues*: only selected residues will be minimized,
 - *Use an harmonic constraint*: enter a force (KJ/mol) acting on selected and non-selected residues to adjust minimizations. Check *Lock/Constraint is for CA only* to restrict the lock or constraint to CA.

On the *Control Panel*, select the residues for which you want to minimize the force field energy, and click *Tools>Energy Minimization*. The force field of the selected atoms is minimized. Provided that the *Show Energy Report* item is checked on the *Energy Minimization Preferences* dialog, an Energy Report is displayed and, on the *Alignment* window, the force field graph is plotted (see point 106). On the *Graphic* window, the structure of the minimized molecule is updated.

NOTE:

Click *File>Save Remote Job* to save the coordinates and related command files needed to run one of the three structure refinement packages: *CHARM*, *AMBER* and *GROMOS* energy minimization jobs. You might need to edit the files manually, but this is a good first approach. This option is currently deprecated since the GROMOS96 force field has been implemented in DeepView, but it has not been removed, as it may be useful to do molecular dynamics.

d. Crystallographic commands

108 • Translating a molecule along its unit cell

Concept

You can translate a molecule (or a copy of the molecule) along the axes of its unit cell (provided that the currently loaded coordinate file contains the crystallographic unit cell information; CRYST record).

Examples of application

Translating copies of molecules in conjunction with applying symmetry operations can be used to examine crystal contacts or to construct biologically active protein assemblies.

Procedure

Click *Tools>Translate Layer along Unit Cell*: this will open a window providing a list of possible translations:

The window provides the following translations:

- along one axis,
- along a and b,
- along a and c
- along b and c
- along a, b, and, c.

(Here, only translations along one axis and along a and b are shown).

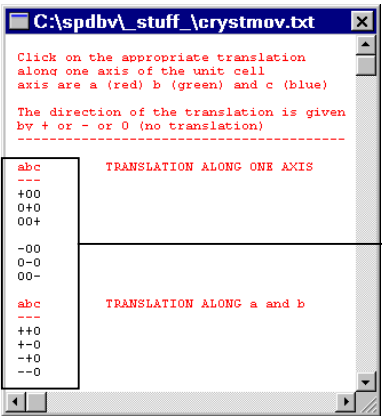

- Click one translation to translate the molecule.

- Control click one translation to translate a copy of the molecule.

Tools>Translate Layer along Unit Cell.

NOTE:

The unit cell must be displayed on the *Graphic* window: this can be achieved by checking the *Draw Unit Cell* option in the *Electron Density Map Parameters* dialog (see point 158).

109 • Applying crystallographic symmetries

Concept

Applying a crystallographic symmetry means generating layers of symmetrical molecules by applying crystallographic symmetry operators.

Examples of application

This function is used to generate the symmetry related molecules in a crystallographic unit cell, e.g. to examine crystal contacts, identify protein-protein contact surfaces or identify the biological active arrangement of an oligomeric protein.

Procedure

Tools>Build Crystallographic Symmetry: this will display a list of space groups with their corresponding symmetry operators. If the current PDB contains a properly formatted CRYST1 card, the correct space group should be shown on top of the list. You can apply the provided operators individually, or all together by clicking on the space group symbol.

Deep View reads the space group of your molecule on the CRYST1 line of the PDB file, in order to provide the correct space group as the first choice. (If Deep View cannot guess the space group of your molecule, you will be prompted for locating it yourself).

Click the space group (appearing in red) to apply all displayed crystallographic operators.

Click a crystallographic operator to apply it.

Each transformation will generate a new layer.

Tools>Build Crystallographic Symmetry.

NOTE:

Clicking *Tools>Build Crystallographic Symmetry* while holding down Ctrl will display a dialog to let you enter a crystallographic operator of your own choice.

110 • Applying transformation matrices

Concept

Applying a transformation matrix (see annex 4: transformation matrices) will alter the coordinates of all or part of a molecule. This can be useful to translate, to rotate, or more generally, to position a molecule in a specific orientation.

PDB files might include transformation matrices in their MTRIX lines. These are matrices that describe specific transformations (for example, 4mdh.pdb contains the transformation matrix needed to superpose chain B onto chain A).

Examples of application

The asymmetric unit of a crystallographic unit cell may contain only part of oligomeric protein structures. Often the information to construct the biologically active form from the initial coordinates is provided as a transformation matrix in REMARK 350 lines of PDB files. See for example files Iout.pdb (trout hemoglobin).

Procedure

General procedure:

Once a molecule has been loaded, select on the *Control Panel* the groups to be transformed and click *Tools>Apply transformation on current layer*. This will display the *Transformation* dialog box to let you enter a transformation matrix:

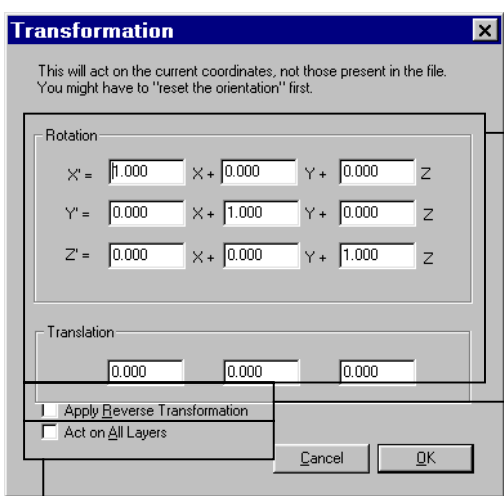

This will act on the current coordinates, not those present in the file. You might have to "reset the orientation" first.

Rotation

X' = 1.000 X + 0.000 Y + 0.000 Z
 Y' = 0.000 X + 1.000 Y + 0.000 Z
 Z' = 0.000 X + 0.000 Y + 1.000 Z

Translation

0.000 0.000 0.000

Apply Reverse Transformation
 Act on All Layers

Cancel OK

- To apply a matrix contained in a PDB file: Open the PDB file, scroll it down until the MTRIX lines (just before the atom coordinates), and click a MTRX line: the matrix values will be copied into the Transformation dialog.

- To apply a matrix of your own choice: Enter here the matrix values.

Deep View does not check if the matrix that you entered is valid: you can undo a transformation by checking the *Apply Reverse Transformation* option (however, this will not let you undo a projection).

Check *Act on All Layers* to apply the transformation matrix to all loaded layers.

Tools>Apply Transformation on Current Layer: Transformation dialog box.

Building a dimer from a PDB file that contains only one chain:

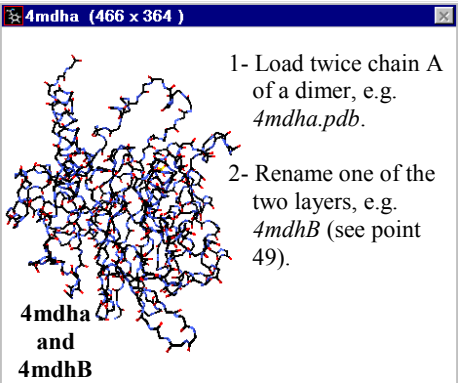

1- Load twice chain A of a dimer, e.g. *4mdha.pdb*.

2- Rename one of the two layers, e.g. *4mdhB* (see point 49).

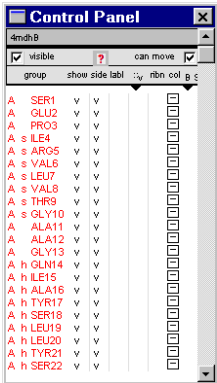

3- Select all residues of *4mdhB*.

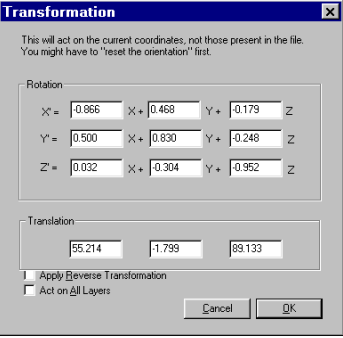

4- Select *Tools>Apply Transformation on current layer* and enter the appropriate matrix to transform chain A into chain B.

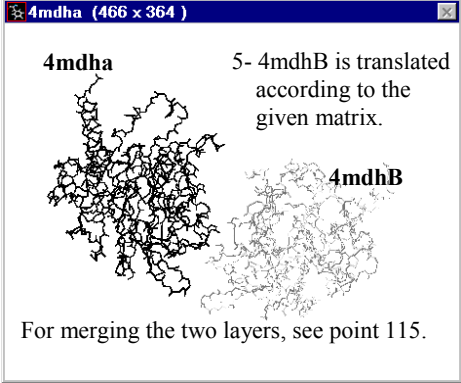

5- *4mdhB* is translated according to the given matrix.

For merging the two layers, see point 115.

Tools>Apply Transformation on current layer

111 • Using electron density maps

Concept

Structures derived from X-ray crystallography can be displayed together with their corresponding electron density map.

Examples of application

Viewing an X-ray-derived structure in its corresponding electron density map allows evaluating the local fit of each residue with the experimental data. This helps to estimate the accuracy of e.g., mobile loops or bound inhibitors.

Procedure

First, open an X-ray-derived structure, and then load its electron density map by clicking *File>Open Electron Density Map*. DeepView currently supports three file formats: O (DN6), CCP4, and X-PLOR (see Annex 4: Electron density maps).

The *Electron Density Map Parameters* dialog lets you adjust the display of the electron density map:

Electron Density Map Parameters

	X	Y	Z
Unit Cell Size (Å)	79.100	79.100	37.900
Cell Angles	90.000	90.000	90.000
Nb Sections	151	151	73
Min Section	-42	4	-11
Max Section	44	81	85

Display

From Section to Section

From Section	25	18	4
to Section	3	46	32

Around CA

CA	7.500	7.500	7.500
----	-------	-------	-------

Display only around Selected Residues (slow!)

Contour a 1.000 sigma with Color Dotted

Contour a 1.500 sigma with Color Dotted

Coarse Contouring Along

X Y Z

Draw Unit Cell

Cancel OK

This field cannot be edited. It provides information on the unit cell and the loaded map:

- unit cell size (Å) along a (X), b (Y), c (Z);
- unit cell α , β , γ angles;
- number of sections in which the cell is divided along each axis.
- range of sections (Min to Max) covered by the map.

Select the display of your map (see below):

- 1 - *From Section to Section*: limits a volume according to the number of sections.
- 2 - *Around CA*: limits a volume around the centered aa, according to the distances that you enter for each axis.
- 3 - *around Selected Residues*: the map is displayed around selected amino acids.

You can enable the visualization of two contours and set their appearance: sigma values (see below), color, and dotted vs. non-dotted.

Enabling a *Coarse Contouring Along* the axes speeds up the display during interactive work, to the detriment of contouring precision. Uncheck these items for picture quality.

Electron Density Map Parameters dialog

PHE 38
ASN 39

PHE 38
CA

Whole molecule

Display

<input type="radio"/> From Section	42	4	-11
to Section	44	81	85
<input type="radio"/> Around CA	6.000	6.000	6.000
<input checked="" type="radio"/> Display only around Selected Residues (slow!)			
<input checked="" type="checkbox"/> Contour a	2.050	sigma with	Color
<input type="checkbox"/> Contour a	1.500	sigma with	Color
<input checked="" type="checkbox"/> Dotted			
<input type="checkbox"/> Dotted			

One contour at 2.05 σ is displayed around all atoms of selected residues (PHE 38 and ASN 39).

Display

<input type="radio"/> From Section	-8	24	8
to Section	14	46	30
<input checked="" type="radio"/> Around CA	6.000	6.000	6.000
<input type="radio"/> Display only around Selected Residues (slow!)			
<input checked="" type="checkbox"/> Contour a	2.050	sigma with	Color
<input type="checkbox"/> Contour a	1.500	sigma with	Color
<input checked="" type="checkbox"/> Dotted			
<input type="checkbox"/> Dotted			

One contour at 2.05 σ is displayed around all atoms within 6 Å of the CA of the centered residue (PHE 38)

Display

<input checked="" type="radio"/> From Section	0	10	0
to Section	40	40	40
<input type="radio"/> Around CA	6.000	6.000	6.000
<input type="radio"/> Display only around Selected Residues (slow!)			
<input checked="" type="checkbox"/> Contour a	2.000	sigma with	Color
<input type="checkbox"/> Contour a	1.500	sigma with	Color
<input type="checkbox"/> Dotted			
<input type="checkbox"/> Dotted			

One contour at 2.0 σ is displayed around all atoms within a volume limited by the given max. and min. section numbers.

Three different displays of electron density maps.

You can display up to two contours for each map. Their appearance (sigma contouring value, color, dotted lines vs. solid lines) can be set on the *Electron Density Map Parameters* dialog, as explained above, and on the *EDM Infos* window:

EDM Infos

? EDM	vis	dot	sigma	corX	corY	corZ	cell	co.
1hel.dn6	v	v	3.000	v	v	v	v	co.
	v	v	1.500					

Contour colors: click a box to change the color.

Check these items to visualize a contour (vis) and to represent it with dotted lines (dot).

Contouring values: click here to edit them.

Check here for a coarse drawing of both contours along the x, y, and z axes.

Check here to visualize the protein unit cell.

EDM Infos window.

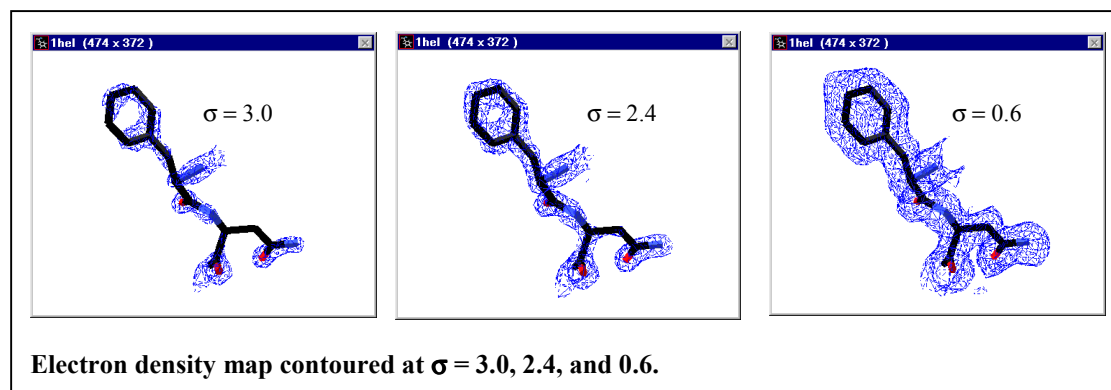

II. WORKING ON A PROJECT

A project consists of a set of layers simultaneously displayed on the *Graphic* window.

By convention, the first loaded layer is the **reference layer**, whereas the **currently active layer**, which is the layer currently governed by the *Control Panel* (see point 70), can be manually selected on the *Control Panel*, on the *Layers Infos* window, and on the *Alignment* window (see points 113-114).

112 • Classification

Advanced commands that can be applied to a project can be grouped into three categories:

Category	Command	Action achieved	See point
Merging commands	• <i>Edit>Create Merged Layer</i> [from Selection]	Builds a new layer by from selected residues (in all other layers).	115
Superposing commands	• <i>Fit>Magic Fit</i> • <i>Fit>Iterative Magic Fit</i> • <i>Fit>Explore Alternate Fits</i>	Automatically superpose two structures	116
	•  • <i>Fit>Fit molecules from</i> [selection]	Superpose two molecules based on selected residues.	117
	• <i>Fit>Improve Fit</i>	Improves a superposition	118
	• <i>Fit>Calculate RMS</i> • <i>Fit>Set Layer Sdt Dev into</i> [B-factors]	Calculate the root mean square deviation of two superposed structures.	119
	• <i>Fit>Reset Orientation (current</i> [layer only]) • <i>Fit>Reset Orientation (every</i> [layer follows])	Reset the orientation prior to a superposition	120
Alignment commands	• <i>Fit>Generate Structural</i> [Alignment]	Generates the structural alignment of superposed molecules	121
	• <i>Fit>Compress Gaps</i>	Compresses non-sense aligned gaps in the <i>Alignment</i> window (gaps present in all layers for a specific column).	122
	• <i>Fit>Reset Alignment</i>	Resets an alignment by striping all gaps	123

Superposing commands:

Superpose a molecule onto another to let you compare molecular structures. This requires fixing a molecule, which is called the **static molecule**, whereas the **superposed molecule** designates the molecule that is moved onto the static one. By default, the reference layer (first loaded layer) is the static molecule, but the role of molecules can be changed on the *RMS & Auto Fit options* dialog (see point 116).

NOTE:

Superposing and alignment commands are mostly employed to prepare modeling-projects. Therefore, the use of these commands will be further developed in the next chapter (Homology Modeling).

113 • Relative movement of layers

When working on a project, it is possible to apply a movement (i.e. rotation or translation) to only some layers of the project. Movement of a layer can be enabled or disabled on the *Control Panel* or on the *Layers Infos* window:

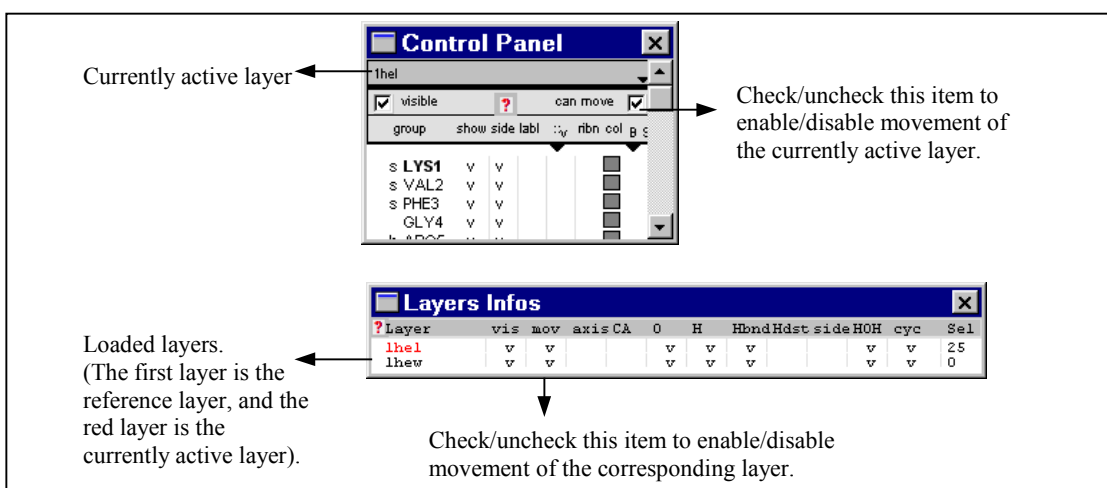

Each loaded layer has its own associated axis, which is displayed on point (0,0,0) of the layer by checking the *axis* item on the *Layers Infos* window. When several layers are loaded, these axes are not necessarily superposed, since crystal structures have no reason to share the same referential.

NOTE:

When only one layer is loaded, it might be more appropriate to use the global axis by checking *Display>Show Axis* (see point 57). The axis will be displayed on the top left corner of the screen, instead of on point (0,0,0).

When some layers are allowed to move and others are not, the atom coordinates of the moving layers will be changed. Follow the steps of the next figure to understand how the atom coordinates are affected:

1- Load 1CRN in two layers and rename them 1CRNA and 1CRNB (see point 49).

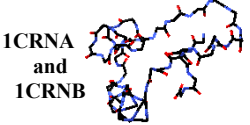

1CRNA and 1CRNB

2- Click *File>Save>Project* to save both layers as a project (see point 31), and close all layers.

3- Reopen the project and display its PDB file (see point 67): the X, Y, Z atom coordinates of both layers remain unchanged (equal to 1CRN atom coordinates).

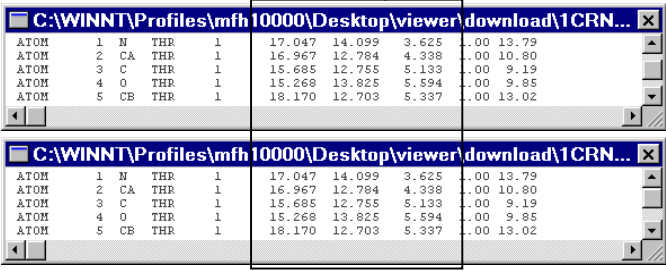

ATOM	1	N	THR	1	17.047	14.099	3.625	1.00	13.79
ATOM	2	CA	THR	1	16.967	12.784	4.338	1.00	10.80
ATOM	3	C	THR	1	15.685	12.755	5.133	1.00	9.19
ATOM	4	O	THR	1	15.268	13.825	5.594	1.00	9.85
ATOM	5	CB	THR	1	18.170	12.703	5.337	1.00	13.02

These are two views of the same PDB file, showing the atom coordinates of layers 1CRNA (up) and 1CRNB (down).

4- Using the *Layers Infos* window, disable movement of layer 1CRNB and translate layer 1CRNA.

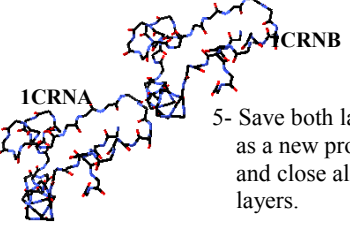

1CRNA and 1CRNB

5- Save both layers as a new project and close all layers.

6- Reopen the project and display its PDB file: the X, Y, Z atom coordinates of 1CRNA have changed, those of 1CRNB remain unchanged.

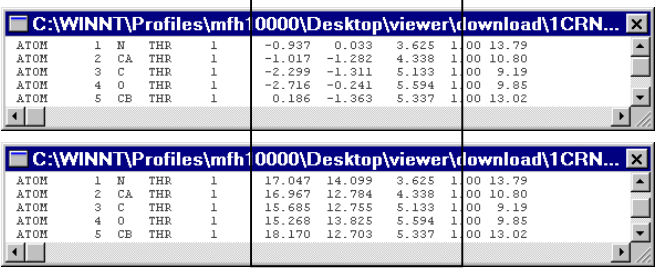

ATOM	1	N	THR	1	-0.937	0.033	3.625	1.00	13.79
ATOM	2	CA	THR	1	-1.017	-1.282	4.338	1.00	10.80
ATOM	3	C	THR	1	-2.239	-1.311	5.133	1.00	9.19
ATOM	4	O	THR	1	-2.716	-0.241	5.594	1.00	9.85
ATOM	5	CB	THR	1	0.186	-1.363	5.337	1.00	13.02

These are two views of the same PDB file, showing the atom coordinates of layers 1CRNA (up) and 1CRNB (down).

7- Reset the orientation of 1CRNA: *Fit>Reset Orientation (current layer only)* (see point 120)



1CRNA and 1CRNB

8- Save both layers as a new project and close all layers.

9- Reopen the project and display its PDB file. The X, Y, Z atom coordinates of 1CRNA were reset: the matrix described on the next page was used to compute the atom coordinates of the original file.

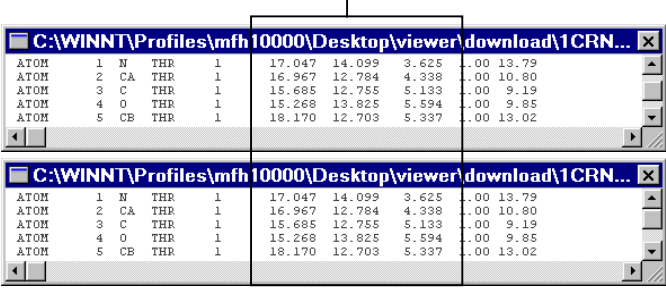

ATOM	1	N	THR	1	17.047	14.099	3.625	1.00	13.79
ATOM	2	CA	THR	1	16.967	12.784	4.338	1.00	10.80
ATOM	3	C	THR	1	15.685	12.755	5.133	1.00	9.19
ATOM	4	O	THR	1	15.268	13.825	5.594	1.00	9.85
ATOM	5	CB	THR	1	18.170	12.703	5.337	1.00	13.02

These are two views of the same PDB file, showing the atom coordinates of layers 1CRNA (up) and 1CRNB (down).

Relative movement of layers: implications on the atom coordinates.

Whenever a layer is moved respect to another layer, a matrix is automatically generated to allow resetting the original orientation of the moved layer. This matrix is included in the PDB file, at the end of each layer:

X-axis
Y-axis
Z-axis

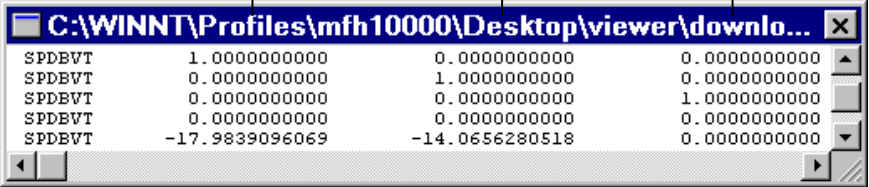

```

SPDBVT  1.0000000000  0.0000000000  0.0000000000  0.0000000000
SPDBVT  0.0000000000  1.0000000000  0.0000000000  0.0000000000
SPDBVT  0.0000000000  0.0000000000  1.0000000000  0.0000000000
SPDBVT  0.0000000000  0.0000000000  0.0000000000  0.0000000000
SPDBVT -17.9839096069 -14.0656280518  0.0000000000  0.0000000000

```

PDB file of the previous project showing the transformation matrix (SPDBVT) generated for 1CRNA. The matrix contains one rotation and two translations:

- The three first lines are used to store a rotation: in this example, it corresponds to the identity, since 1CRNA was not rotated.
- The fourth line stores a translation to be applied before the rotation: in this example, the translation is null.
- The last line contains a translation to be applied after the rotation: the values show that 1CRNA was translated along the X and Y axes. This translation was used in the former figure (steps 7-9) to compute the original atom coordinates.

Translation matrices generated after a layer has been moved respect to another.

114 • The *Alignment* window

Most advanced functions that are used to work on projects use the *Alignment* window as an information panel (superposing commands) or as a working tool (alignment commands):

Click the question mark for getting help on the window.

List of loaded molecules, with the currently active layer in red. Click the page icon to display the alignment in a *Text* window.

Alignment window



Field for information on the pointed residue.

Amino-acid sequences of loaded layers:

- residues are colored as selected in the *Control Panel* or with the *Color* menu (see points 81 and 62-66),
- selected residues appear in inverse video,
- pointing a residue will make it blink on the *Graphic* window.

a. Merging commands

115 • Merging layers

Concept

Given several loaded molecules, selected residues on each layer can be merged in a new layer.

Examples of application

By merging parts of proteins from different molecules, you can build a new entity. For example, given an ExPDB file containing chain A of a dimer, you can build the full dimer by:

loading twice the ExpDB file containing chain A,
 applying to one of the two layers the matrix that transforms chain A into chain B (see point 110),
 selecting all residues in both layers and,
 merging both layers.

Procedure

-General procedure

On the *Control Panel*, select for each layer the groups that you want to see in the new merged layer. Then, click *Edit>Create Merged Layer from Selection*: the "merged" molecule will appear in a new layer named *_merge_*. You can rename it by using the *Rename Current Layer* command under the *Edit* menu (see point 49).

NOTES:

Edit>Create Merged Layer from Selection can be used as a copy-paste function.

Groups will be saved in the order of their original layers, i.e. all selected residues of the first layer, then second, etc. When creating chimerical proteins, make sure the order of layers corresponds to the N→C order of the selected residues.

b. Superposing commands

116 • Superposing two structures

Concept

Two given structure can be superposed on the *Graphic* window.

Examples of application

Superposing two molecules lets you compare their structures, for various purposes. See for example next chapter on homology modeling.

Procedure

The *Fit* menu offers three commands (*Magic Fit*, *Iterative Magic Fit* and *Explore Alternate Fits*) to superpose a molecule onto another. Invoking these commands displays the *RMS & Auto Fit Options* dialog, in which you can specify:

Select here:
 - the static molecule (reference layer, by default).
 - the superposed molecule.

Select the type of atom to be considered to superimpose the superposed molecule onto the static molecule. Note that *Sidechain atoms only* and *All atoms* can only be used when selected residues are identical.

Fit>Magic Fit, Iterative Magic Fit, Explore Alternate Fits: RMS & Auto Fit options dialog.

The following actions can be achieved:

<i>Fit</i> menu	
Command	Action
<i>Magic Fit</i>	DeepView compares the primary sequences of the two molecules using a PAM matrix

	<p>(PAM 200 by default), selects the best matching fragments of amino acid pairs and, based on them, superposes the molecules on the <i>Graphic</i> window.</p> <p>This is the quickest way to test if two molecules could fit, but it will only work if a reasonable sequence homology is found. This fit can usually be improved.</p> <p>For information purposes, involved residues are selected on the <i>Control Panel</i> and on the <i>Alignment</i> window.</p>
<i>Iterative Magic Fit</i>	<p>DeepView starts with an initial superposition as described above (<i>Magic Fit</i>). Then, the fit is optimized by iterating through several <i>Improve Fit</i> cycles (see point 118). Finally a structural alignment is generated (see point 121).</p> <p>This method is slightly slower than <i>Magic Fit</i>, but gives a better global superposition.</p> <p>Depending on the option you selected on the <i>RMS & Auto Fit options</i> dialog, the fit is optimized by minimizing the RMS deviation between Cα, backbone, sidechain, or all atoms. The RMS deviation for the last cycle is displayed in the tool bar message space.</p> <p>For information purposes, involved residues are selected on the <i>Control Panel</i> and on the <i>Alignment</i> window.</p>
<i>Explore Alternate Fits</i>	<p>DeepView looks for alternate superpositions, which are displayed on a result list (text file named <i>match.txt</i>, stored in the <i>temp</i> directory, see figure below).</p> <p>This method is not using any sequence information and is much slower than the two previous ones. It is useful to explore local matches (in cases of hinge motions for example), or to superpose two molecules that have a sequence identity so low that <i>Magic Fit</i> fails.</p> <p>Select an alternate superposition from the list to visualize it on the <i>Graphic</i> window. For information purposes, superposed residues are selected on the <i>Control Panel</i> and on the <i>Alignment</i> window. The backbone and sidechains will be colored by RMS.</p>

Changes occurring on the *Graphic* window, on the *Control Panel*, and on the *Alignment* window:

1a4fa (596 x 431)

Superposed molecule: 1a0va.

Before the fit.

Static molecule: 1a4fa.

Fit

1a0va (596 x 431)

1a0vae is superimposed onto 1a4fa

After Magic Fit or Iterative Magic Fit.

1a0va (596 x 431)

Backbone and sidechains are colored by RMS (here only the backbone is shown for clarity).

After Explore Alternate Fits.

NOTE:
After *Iterative Magic Fit* and *Explore Alternate Fits*, the message space of the *Toolbar* displays the number of atoms that were adjusted and their RMS.

#MATCH	RTMAT	137	1a0va
	RTMAT	137	1a0va
	RTMAT	136	1a0va
	RTMAT	136	1a0va
	RTMAT	136	1a0va

Number of residues involved followed by name of the superposed layer.

Explore Alternate Fits result list: *match.txt*.
Select one solution to visualize it on the *Graphic* window and to display on the *Toolbar* the number of atoms involved and their RMS.

Fit>Magic Fit followed by **Iterative Magic Fit** followed by **Explore Alternate Fits**: changes occurring on the *Graphic* window.

Before the fit.

After Magic Fit.

After Iterative Magic Fit.

After Explore Alternate Fits.

Amino acids that fit the static molecule are selected (they turn red).

Amino acids with a high RMS are deselected (they turn black)

Backbone and sidechains are colored by RMS, according to the selected solution on the *match.txt* result list.

Fit>Magic Fit followed by Iterative Magic Fit followed by Explore Alternate Fits: changes occurring on the Control Panel. (Here the superposed molecule is shown).

NOTE:

Applying *Iterative Magic Fit* is equivalent to applying *Magic Fit* followed by *Improve Fit* and *Generate Structural Alignment* (see below).

117 • Superposing two molecules based on selected residues

Concept

You can superpose a selected part of a superposed molecule onto a corresponding selected part of a static molecule.

Examples of application

By superposing precise domains, you can see the relative movement of other specific domains between the two molecules: this lets you study hinge motions, for example.

By superposing e.g. only the cofactor of two enzymes, it is possible to compare the binding sites of otherwise structurally dissimilar proteins.

Procedure

Based on 3 selected atoms:

Click the  icon (11th tool): on the message space below the tools: you will be prompted to pick three atoms on the static and the superposed molecules. On the *Graphic* window, the superposed molecule will be superposed onto the static molecule according to the three selected pairs of atoms.

Based on a set of selected residues:

Select on the *Control Panel* an equal number of residues from the two layers, and click *Fit>Fit molecules (from selection)*. On the *Graphic* window, selected amino acids of the superposed molecule will be superposed one-to-one onto selected amino acids of the static molecule. This fit is more accurate than the three-corresponding-atoms superposition described above, and can involve more than three residues.

118 • Improving a superposition

Concept

Given two similar structures that were previously superposed with a fitting tool (*Fit>Magic Fit*, see point 116; or *Fit>Fit Molecules from Selection*, see point 117), an improved superposition is done by iterating through:

- 1- Generation of a structural alignment (see point 121) to find those pairs of residues that are spatially close to each other. These will be added to the previous selection .
 - 2- Superposing again the two structures based on the new selection.
- Iterations are done until the RMS cannot be lowered while keeping the number of matching residues as high as possible.

Procedure

On the *Control Panel* select the superposed molecule (second loaded layer, by default) so that it becomes the currently active layer and then, select *Fit>Improve Fit*.

NOTE:

The process is aborted if DeepView cannot find similar atoms close to each other. This will happen if you try to improve the fit for two proteins that have not been superposed first.

119 • Evaluating a superposition

Concept

DeepView lets you evaluate the quality of a superposition between two molecules by calculating the RMS (between 2 layers) or the standard deviation (between more than two layers) at each residue.

Procedure

On the *Control Panel* select for each concerned layer the same number of corresponding residues and then, select:

<i>Fit menu</i>	
Command	Action
<i>Calculate RMS</i>	<p>Evaluates the quality of a fit by calculating the RMS (Root Mean Squared deviation, see Annex 4: RMSD) between two superposed molecules. The <i>RMS &Auto Fit options</i> dialog is displayed to let you specify which are the two molecules (static and superposed) to be considered, as well as which atoms are to be used in the RMS calculations (see point 116).</p> <p>Only selected groups on the <i>Control Panel</i> are taken into account: HETATM should not be included unless you are sure that their atoms appear in the same order in the two PDB files.</p> <p>On the <i>Toolbar</i>, the message space will display the number of atoms that were involved in the calculation and their RMS computed value. On the <i>Alignment</i> window, pointing a residue belonging to the superposed molecule (second layer) will calculate the backbone RMS deviation to the aligned residue in the static molecule (first layer). The RMS computed value will be displayed on the field for information of the pointed residue (see point 114)</p> <p><i>NOTE:</i> Hydrogen atoms are never used for these calculations.</p>
<i>Set Layer Std Dev into B-factors</i>	<p>This command is useful to analyze molecular dynamic results or NMR files. Based on the alignment, the Standard Deviation of each corresponding atom of each residue is computed and assigned to the B-factor column of the PDB file. Proteins are then accordingly colored, with those parts that move the most being highlighted in red.</p> <p><i>NOTE:</i> This command requires that all layers have exactly the same sequence.</p>

120 • Resetting orientations

Concept

The orientation of a molecule is brought back to its original position before a fitting operation.

Procedure

On the *Control Panel*, make sure that the static molecule is not selected as the currently active layer, and then apply one of the two following commands:

Fit menu	
Command	Action
<i>Reset Orientation (current layer only)</i>	Moves the superposed layer back to its original position before a fitting operation.
<i>Reset Orientation (every layer follows)</i>	Moves both the superposed layer and all static layers back to the original position of the superposed layer before a fitting operation. This is useful to change the coordinates of several layers, which will be put in the referential of the superposed molecule.

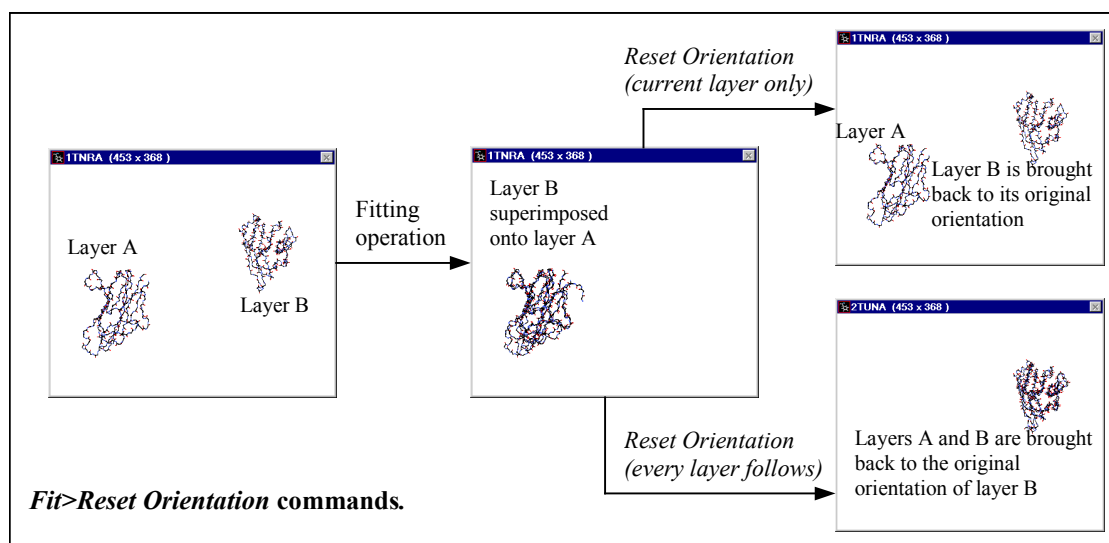

c. Alignment commands

121 • Generating a structural alignment

Concept

A structural superposition between two molecules is used to find pairs of residues close to each other. These are aligned on the *Alignment* window, showing pairs of residues with similar structural roles.

Procedure

Before invoking this tool, you should already have done a *Magic Fit* of two molecules.

Select *Fit>Generate Structural Alignment*: on the *Alignment* window, residues of the superposed molecule that are spatially close to residues of the static molecule are aligned. Appropriate gaps are inserted in the sequences:

After Magic Fit



Best matching residues are highlighted.

After Generate Structural Alignment



Pairs of residues that are spatially close are aligned. Appropriate gaps are inserted in the sequences to indicate a lack of structural correspondence.

Fit>Magic Fit followed by *Fit>Generate Structural Alignment*

122 • Compressing gaps

Concept

On the *Alignment* window, gaps aligned with gaps are removed. These non-sense alignments may occur if you have edited the alignment, deleted some residues, or removed a layer from the alignment.

Procedure

Select *Fit>Compress Gaps*.

123 • Resetting alignments

Concept

Un-aligns the currently active layer by resetting its sequence on the *Alignment* window: the sequence will start at the left of the *Alignment* window and will show no gaps.

Procedure

Select *Fit>Reset Alignment*.

HOMOLOGY MODELING

124 • Overview

DeepView offers a series of commands that let you model new structures by submitting modeling requests to Swiss-Model, a server for automated homology modeling.

The *Glossary* given in Annex 5 includes some homology modeling terminology. To facilitate understanding of the following points, the most essential terms are here introduced. This chapter can not provide an introduction to homology modeling, for further details please refer to the references provided at the end of this manual (page 137 ff.).

Homology modeling, also called **comparative protein modeling** or **knowledge-based modeling**, is the process by which a 3D model of a **target sequence** is built based on an homologue experimentally solved structure (experimental processes include X-ray crystallography and solution nuclear magnetic resonance).

A **target sequence** is the primary sequence of a protein whose structure has to be modeled. When first loaded in the workspace, it is provisionally drawn as a long helix. A **template structure**, or simply a **template**, is an experimentally solved structure used as a scaffold to model the structure of the target sequence. **Template sequence** is the primary sequence of a template.

125 • Swiss-Model

Swiss-Model is a server for automated **comparative protein modeling**. It is available free of charge at the **ExPASy** (Expert Protein Analysis System) site <http://www.expasy.org/swissmod>, where extensive documentation on the architecture and use of Swiss-Model can be found.

The **ExPASy** (Expert Protein Analysis System) site is the proteomics server of the Swiss Institute of Bioinformatics (SIB). The server is dedicated to the analysis of protein sequences and structures. Amongst other documentation, it curates several protein databases such as **SWISS-PROT**, **TrEMBL**, and **PROSITE**, and provides links to many other molecular biology databases, such as **PDB**.

SWISS-PROT is a protein sequence database that provides high quality annotations (such as description of the function of proteins, of the structure of protein domains, of post-translational modifications, of variants, etc). **TrEMBL** is a computer-annotated supplement of SWISS-PROT that contains all the translations of EMBL nucleotide sequence entries not yet integrated in SWISS-PROT. **PROSITE** is a database of protein families and domains. It consists of biologically significant sites, patterns and profiles that help to reliably identify to which known protein family (if any) a new sequence belongs. **PDB**, or Protein Data Bank, is an international repository of 3-D protein structures primarily determined by X-ray crystallography and solution nuclear magnetic resonance. **ExPDB** is a Swiss-Model template database of protein structures, containing one entry for each individual protein chain of the PDB proteins.

Several modeling modes are currently available at the **Swiss-Model** server:

First Approach mode:

The primary sequence of a protein to be modeled can be directly submitted to the Swiss-Model server in FastA format or even by simply entering its SWISS-PROT accession code. This *First Approach* modeling mode is based on a fully automated alignment of template and target sequences.

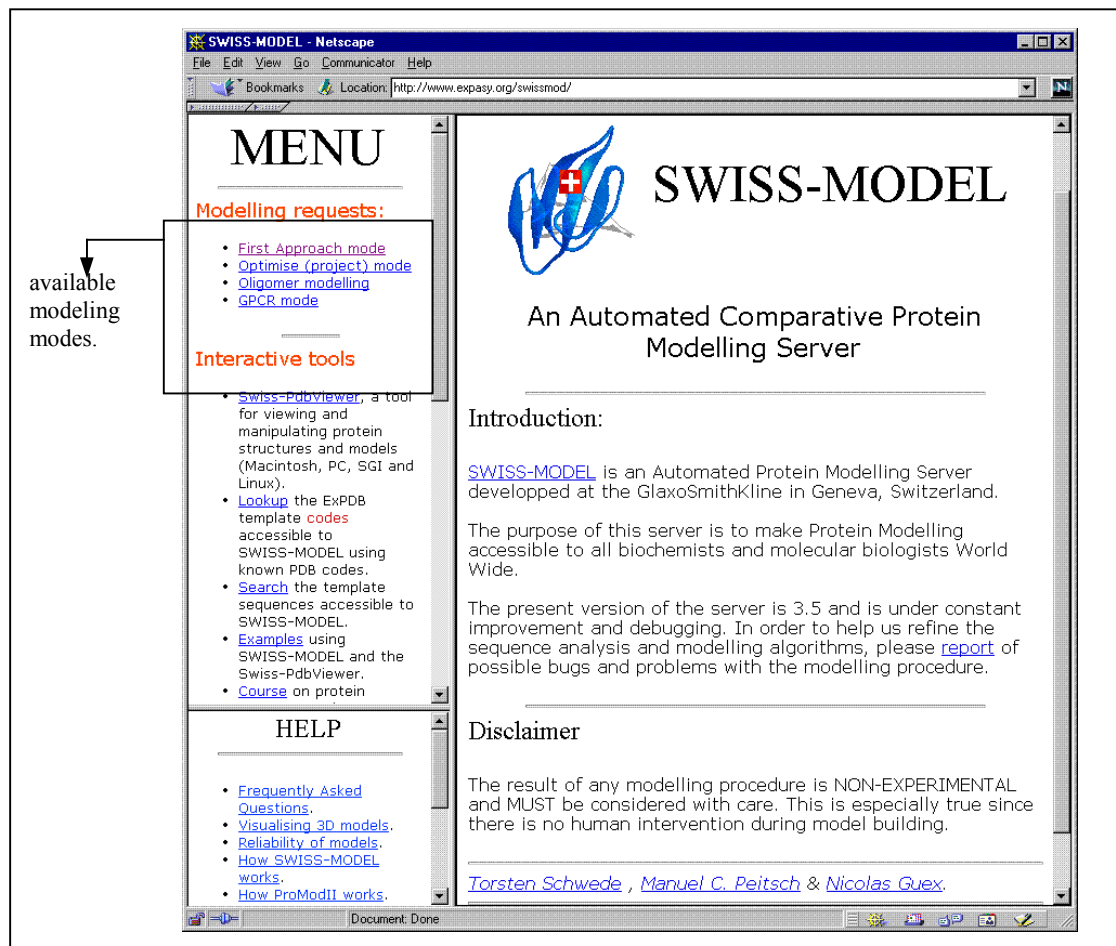

Optimise (project) mode:

Instead of using the Web interface, requests can be submitted as *modeling-projects* from DeepView. This *Optimise* mode offers a much better control over the whole modeling process, since it lets you perform and improve the alignments.

Oligomer modeling:

This mode is used to model multimeric proteins. Requests must be sent from DeepView.

GPCR mode:

Models the 7 transmembrane helical part of G-protein coupled receptors (GPCR).

126 • The *Optimise (project) mode*

The following points explain how to perform a submission to Swiss-Model in the *Optimise (Project) mode*, which requires going through the following steps by using DeepView:

Step	Command	Action achieved	See point
Loading files	<ul style="list-style-type: none"> • <i>File>Import>Grab from server SwissProt Seq</i> <li style="text-align: center;">or • <i>SwissModel>Load Raw Sequence</i> 	Load the target sequence to be modeled	127
	<ul style="list-style-type: none"> • <i>Edit>BLAST Selection vs. ExpDB</i> <li style="text-align: center;">or • <i>SwissModel>Find Appropriate [ExpDB Templates]</i> 	Load homologous template(s)	128
	<ul style="list-style-type: none"> • <i>Fit>Magic Fit</i> followed by • <i>Fit>Generate Structural Alignment</i> <li style="text-align: center;">or • <i>Fit>Iterative Magic Fit</i> 	Only if more than one template were loaded: superpose all templates and generate a structural alignment	129

	• <i>Fit>Fit Raw Sequence</i>	Aligns the target sequence onto the template(s) and displays a preliminary 3D model for the target	130
	• <i>Alignment window</i>	The sequence alignment can be refined manually	132
	• <i>SwissModel>Homo Multimer Mode</i> (To be enabled before manually refining the alignment)	Enables the multimer mode (optional), which is useful if the target sequence contains two or more identical chains.	133
Submitting a modeling-project	• <i>SwissModel>Submit Modeling [Request]</i>	Submits a generated modeling-project to Swiss-Model	134-135
Improving a returned model	• <i>Select>aa Making Clashes</i>	Selects those residues of the modeled molecule whose atoms make clashes with other residues	136
	• <i>Tools>Fix Selected Sidechains</i>	Browses the rotamer library to choose the best rotamer for a selected aa	
	• <i>Build>Build Loop</i> • <i>Build>Scan Loop Database</i>	Computes or loads a series of loops connecting two amino acids	

NOTE:

The following commands under the *SwissModel* menu are currently not used or still in development:

<i>Load FoldFit Alignment</i> <i>Save FoldFit Alignment</i>
<i>Ignore Selected AA during modeling</i> <i>Use Selected AA during modeling</i> <i>Draw Residues to Ignore as *</i>
<i>Set current layer as reference</i> <i>Move raw sequence into structure</i> <i>Move structure into raw sequence</i>
<i>Lock Selected Residues of Model</i> <i>Unlock Selected Residues of Model</i>
<i>Build Preliminary Model</i> <i>Save Optimize Model Job</i>

I. LOADING FILES

127 • Loading a target sequence

DeepView supports two formats to load a target sequence (i.e. a protein to be modeled): FastA and SWISS-PROT.

The target sequence is a FastA file, not included in the SWISS-PROT database:

It can be loaded by selecting *SwissModel>Load Raw Sequence*. The *Select a Text File* dialog is displayed to let you browse through your computer for the FastA target sequence.

The target sequence is a SWISS-PROT file:

It can be loaded by selecting *SwissModel>Load Raw Sequence* as explained above, or it can be directly imported by clicking *File>Import*. The *Import* dialog is displayed: enter the SWISS-PROT accession code and press the *SwissProt seq.* button (see point 21).

When a SWISS-PROT sequence is imported into DeepView, the header information is lost. This can be retrieved in a separate window by selecting again *File>Import*, and then reentering the SWISS-PROT accession code and pressing the *SwissProt text* button in the *Import* dialog. Displaying the SWISS-PROT header might be useful to find out if the protein contains target sequences that need to

be removed before performing an alignment, or to identify active sites residues to help guide the alignment.

NOTES:

DeepView lets you load only one target sequence at a time (except in the special case of multimers, where the sequence of the chains must be separated by a semicolon and be in FastA format).

Since no structural information is available for a target sequence, DeepView provisionally models it as an alpha-helix:

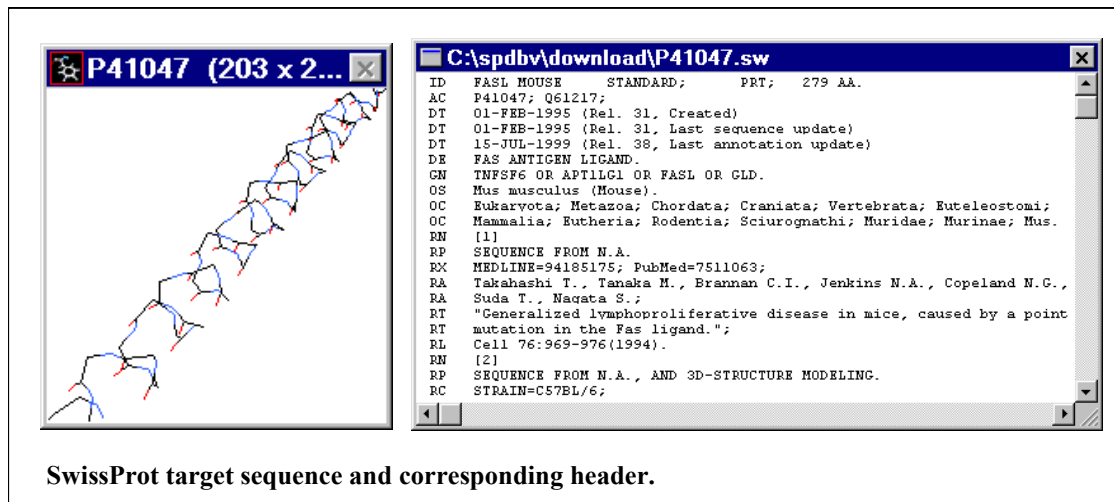

128 • Finding homologous templates

DeepView offers two ways to search for and load homologous templates (i.e. proteins whose structure has been experimentally solved and whose sequence is similar to the target sequence), which can be PDB or ExPDB files.

Select *SwissModel*>*Find Appropriate ExPDB Templates*:

Automatically, your Web browser will open at the BLAST search page of the ExPASy site, where your sequence has been already entered in FastA format. BLAST will then be used to search the ExPDB database for appropriate templates. The ExPDB database is a subset of the PDB database, containing all templates available for the SwissModel server in separate entries for every chain. A result list will be displayed:

Select an accession code to directly download the ExpDB file or to save it first and then opening it from Deep View.

Click *Detail* to see the target/template alignment details.

Link to PDB entry on the PDB Web site

	download ExpDB	Blast Score	see	Exp.	Reso.	Parent PDB	Description
<input type="checkbox"/>	1TNRA	6e-14	Detail	X-RAY	2.85	1TNR	TUMOR NECROSIS FACTOR RECEPTOR P55 (EXTRACELLULAR DOMAIN) COMPLEXED WITH TUMOR NECROSIS FACTOR-BETA
<input type="checkbox"/>	1DOGD	3e-13	Detail	X-RAY	2.40	1D0G	CRYSTAL STRUCTURE OF DEATH RECEPTOR 5 (DR5) BOUND TO APO2L/TRAIL
<input type="checkbox"/>	1DOGA	3e-13	Detail	X-RAY	2.40	1D0G	CRYSTAL STRUCTURE OF DEATH RECEPTOR 5 (DR5) BOUND TO APO2L/TRAIL
<input type="checkbox"/>	1D0GB	3e-13	Detail	X-RAY	2.40	1D0G	CRYSTAL STRUCTURE OF DEATH RECEPTOR 5 (DR5) BOUND TO APO2L/TRAIL
<input type="checkbox"/>	1DU3K	7e-13	Detail	X-RAY	2.2	1DU3	CRYSTAL STRUCTURE OF TRAIL-SDRS
<input type="checkbox"/>	1DU3E	7e-13	Detail	X-RAY	2.2	1DU3	CRYSTAL STRUCTURE OF TRAIL-SDRS

BLAST score Experimental details: method and resolution. Protein description.

SwissModel>Find Appropriate ExpDB Templates: result list.

Select all residues on the *Control Panel* and click *Edit>Blast Selection vs. ExpDB*: DeepView will connect to the DeepView server to run a BLAST search vs. ExpDB database for homologous templates (see point 100).

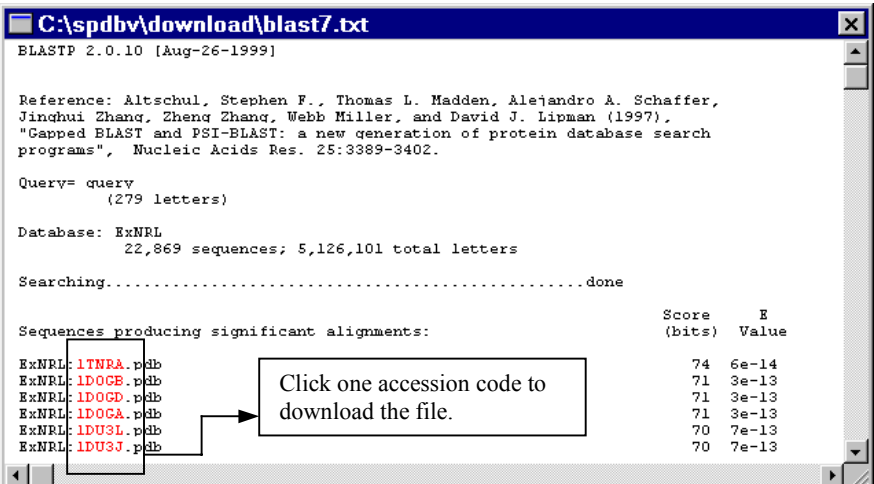

For explanations on this result list see point 100.

Edit>BLAST Selection vs. ExpDB: result list.

NOTE:
 A template can also be “manually” loaded by clicking *File>Import* and, on the *Import* dialog that is displayed, entering its accession code before pressing the *PDB file* or *ExpDB file* buttons, depending on the template file-type.

II. GENERATING A MODELING-PROJECT

Generating a modeling-project means adjusting a sequence alignment between the target and the templates. This is the alignment that will be submitted to and used by Swiss-Model to construct the 3D structure of the target sequence. The following steps need the display of the *Alignment* window.

129 • Superposing and aligning all homologous templates

If several templates were selected, they first of all need to be superposed by doing one of the following: click *Fit>Magic Fit* and *Fit>Generate Structural Alignment*, or click *Fit>Iterative Magic Fit* (the structural alignment will be automatically done).

For further details on these procedures see points 116-118.

Before the fit

Template 1

Fit

Target sequence

Template 2

Alignment

P41047 MQQPMNYPCQIFWVDS SATSSWAPPGSVFPCPCGPRGPDQRRPPPPPPV

1tnra KPA AHLIGDPSKNSLLWRANTDR AFLDGFSLSNNSLLVPTSGIYFVYSQV

2tunb T P S D K P V A H V V A N P Q A E G Q L Q W L N R R A N A L L A N G V E L R D N Q L V V P S E G L Y L I

Target sequence

Templates

After the fit

Template 2 onto template 1

Target sequence

Alignment

P41047 MQQPMNYPCQIFWVDS SATSSWAPPGSVFPCPCGPRG

1tnra K P A A H L I G D P S K N S L L W R A N T D R A F L D G F S L S N N S L L V P T S G I Y F V

2tunb T P S D K P V A H V V A N P Q A E G Q L Q W L N R R A N A L L A N G V E L R D N Q L V V P S E G L Y L I

(A) ILE34

Target sequence

Aligned templates

Templates alignment.

130 • Aligning the target sequence onto the templates

Click *Fit>Fit Raw Sequence* to generate a sequence alignment between the target and the templates. This will provide the target with a preliminary 3D structure, which is only to help you further adjust a better alignment:

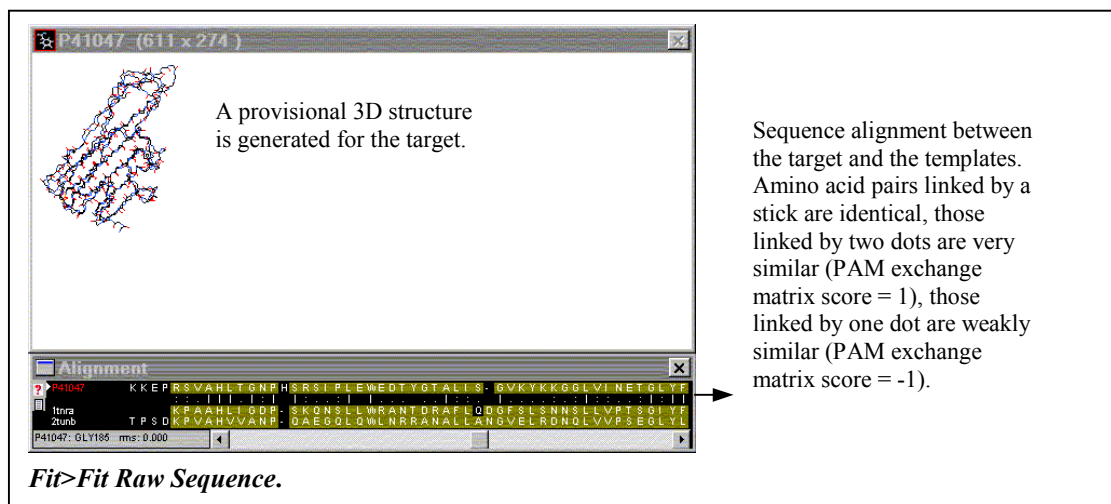

NOTES:

The *Fit Raw Sequence* command is only available if at least one structure and a target sequence are loaded.

If more than one structure is loaded, the target sequence is aligned to the first loaded (reference layer).

Applying *Fit Raw Sequence* automatically computes the threading energy for the target. The corresponding threading energy plot can be displayed by:

- selecting the target as the currently active layer,
- clicking the small white arrow on the *Alignment* window.

131 • Viewing the threading energy

The *SwissModel* menu offers three commands to let you visualize the threading energy of the sequence alignment between the target and the templates:

SwissModel menu	
Option	Action
<i>Update Threading Display Automatically</i>	Enabling this option updates the threading energy plot for the target sequence whenever the sequence alignment is edited (see point 105).
<i>Update Threading Display Now</i>	If the former option is not enabled, select this option to update the threading energy plot for the target sequence.
<i>Auto Color by Threading Energy</i>	Enabling this option colors the residues by threading energy, updating the coloring whenever the sequence alignment is edited (see point 132). Residues are colored on the <i>Graphic</i> , <i>Alignment</i> and <i>Control Panel</i> windows. Blue indicates a low energy, green is for intermediate values, and red indicates a high energy.

132 • Manually refining the alignment

The alignment of the target sequence onto the templates can be manually refined on the *Alignment* window by translating residue, or inserting and removing, gaps:

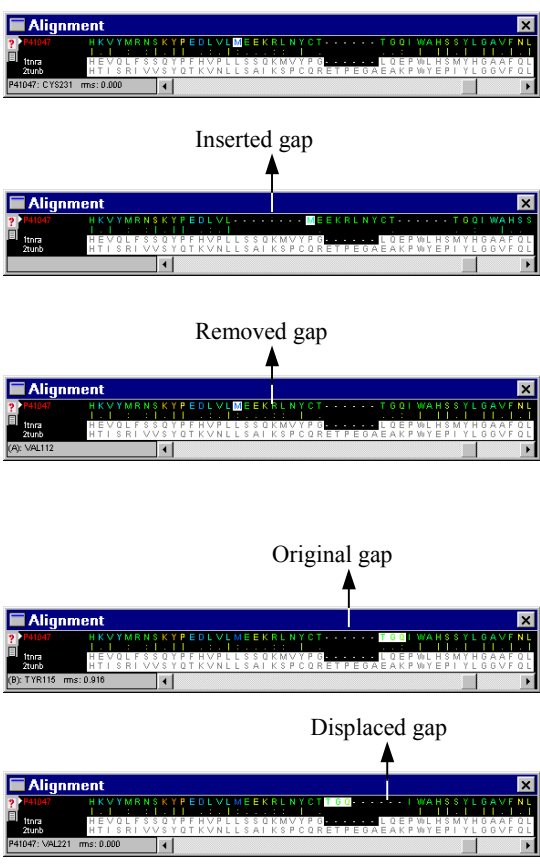

Inserted gap

Removed gap

Original gap

Displaced gap

Select an amino acid on the target sequence and use the space bar to insert a gap.

Select an amino acid on the target sequence and use the backspace key to remove a gap.

Select one or a group of amino acids on the target sequence and use left/right arrow keys to displace the gap.

Procedures to manually adjust an alignment.

The preliminary 3D structure and the threading energy plot help find the most satisfactory adjustment:

Graphic window: a gap in the target sequence is represented by a long peptidic bond. Its display is updated whenever the gap is adjusted in the alignment window, thus letting you assess the 3D quality of your adjustments.

Alignment window: the threading energy plot and the total threading energy are also updated whenever the gap is adjusted in the alignment window, to let you evaluate the quality of your adjustments.

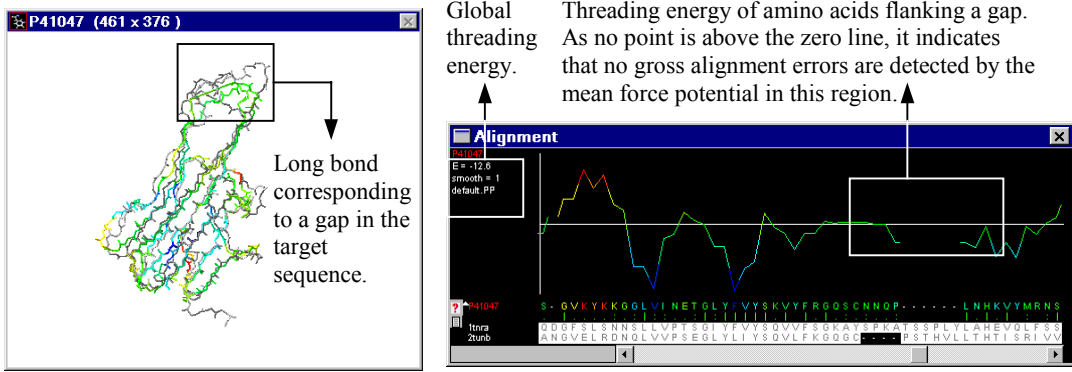

Global threading energy.

Threading energy of amino acids flanking a gap. As no point is above the zero line, it indicates that no gross alignment errors are detected by the mean force potential in this region.

Long bond corresponding to a gap in the target sequence.

Elements that help find the most satisfactory alignment: see example in the figure below.

133 • Setting the multimer mode (in development)

If you have to model a symmetric homo-oligomeric structure, *SwissModel>Homo Multimer Mode* enables the multimer modeling mode, in which the alignment adjustments manually performed (see point 132) on one monomer will be reflected in all the other monomers. This requires that all monomers have exactly the same amino-acid sequence.

open the FASTA file with a text editor and generate the polymer by copying the monomer sequence, separating each copy with a semicolon,

SwissModel>Load Raw Sequence to Model: opens the FASTA polymer. Each monomer will be displayed as a helix, and will have its own chain identifier.

Homologous polymer templates will be PDB files (ExPDB files contain only one chain) that can be opened from local directories (*File>Open PDB File*) or imported from the PDB server (*File>Import>Grab form server PDB file*).

III. SUBMITTING A MODELING-PROJECT

134 • Setting your e-mail

Swiss-Model returns constructed 3D structures by e-mail. Click *Preferences>Swiss-Model* to set your name and e-mail (see point 163).

135 • Submitting the request

To submit a request click *SwissModel>Submit Modelling Request*. This will display a *Save request as* dialog to let you select a name and a destination folder for your modeling project.

As soon as the project is saved, DeepView opens your Web browser at the Swiss-Model Optimise Request mode page and loads your project:

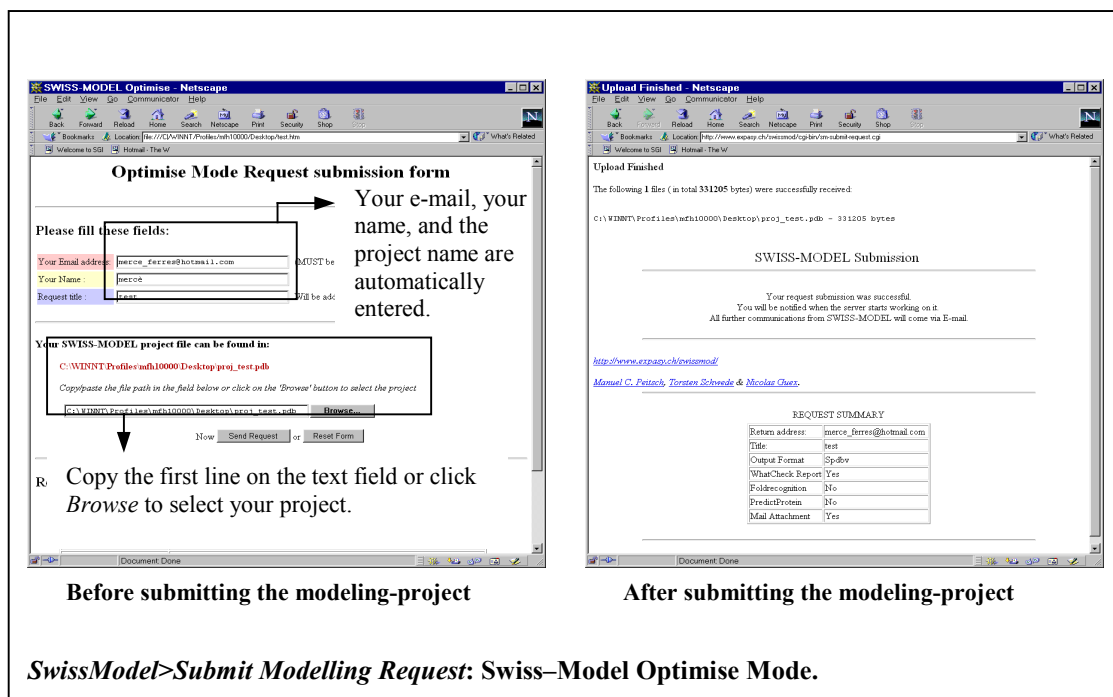

SwissModel requests are submitted to a batch queuing system. As soon as the server starts working on your submission (depending on the server load; normally within some minutes up to some hours), you will receive a Welcome e-mail from Swiss-Model, in which you will be given a Process Identification code corresponding to your request (for example: AAAa02MdM). The modeling results should then follow (at maximum within the next 4 hours).

IV. EVALUATING AND IMPROVING THE MODEL

The constructed 3D model will be sent to you by e-mail as an attached PDB file named as the Process Identification code, and containing the submitted alignment:

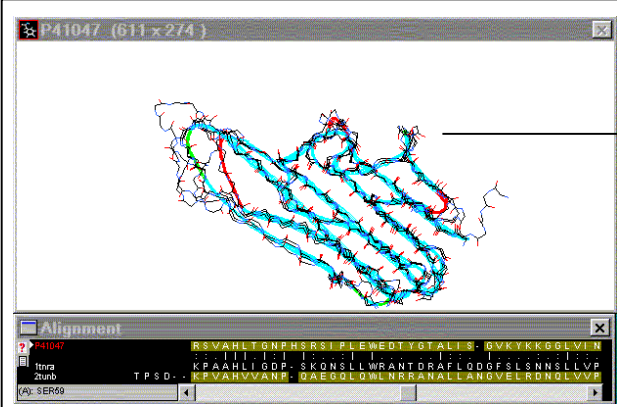

A ribbon representation of the model is colored by the Confidence Factor (see annex 4) to let you estimate the quality of the model. Regions of the model that appear in red (C-factor of 99.99) have been completely rebuilt and are to be considered with caution. The rest of the residues are colored accordingly to the number of templates used to build the residue, using a color gradient from green (only one template) to blue (more templates used).

Model returned by Swiss-Model.

Depending on the quality of the model, you might need to:
 proceed to a minor adjustment of the structure (see point 136),
 resubmit a new modeling-project after correcting the alignment (see point 137).

136 • Minor adjustments

For minor adjustments of the sidechains you can subsequently apply the two following commands:

Command	Action
<i>Select>aaMaking Clashes</i>	Selects residues with atoms too close to atoms of other residues (i.e. atoms closer than the sum of their van der Waals radii, see point 56)
<i>Tools>Fit Selected Sidechains</i>	A submenu allows finding the best rotamers, for previously selected amino acids, according to three techniques (see point 95)
<i>Build>Build Loop</i> or <i>Build>Scan Loop Database</i>	Loops can also be adjusted by proceeding as explained in point 90.

137 • Resubmitting the modeling-project

Wrong alignments and improper placement of gaps / insertions are a common reason for bad models or complete failure of the modeling procedure. Refine the alignment as explained above (see point 132) and resubmit the project (see point 134-135).

Display Modes

DeepView offers three modes to visualize a molecule on the *Graphic* window:

Mode	Main display features
<i>Normal</i>	Backbones, sidechains, ribbons, and molecular surfaces are rendered as wire frame. Van der Waals and accessible surfaces are dotted. This is the fastest rendering mode (not available for SGI and Linux versions).
<i>3D-rendering</i>	Renders molecules in solid 3D. Two 3D-rendering types are available: one applies to ribbons and surfaces only, and the other renders the whole molecule in solid 3D.
<i>Stereoscopic</i>	Allows visualizing molecules in real 3D. Depending on the characteristics of your computer, up to three stereoscopic modes might be available.

138 • Slab Display Mode

Click *Display>Slab*: this toggles on and off the slab mode, which delimits a molecule slab parallel to the screen by removing those groups that reside too far into or out the screen.

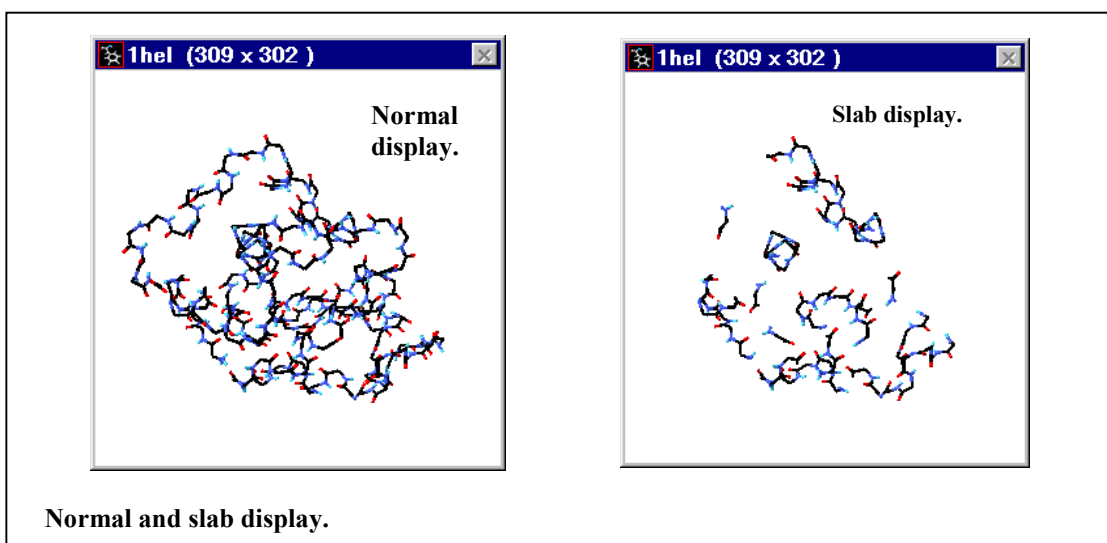

The slab depth (in Å) can be adjusted in *Preferences>Display* (see point 167). The slab will display or hide an entire group based on the depth of the C α atoms for amino acids, and C1' for nucleotides. This prevents an excessive number of unlinked atoms and bonds in the display. Atoms from all other groups are clipped independently.

The slab can be translated along the axis perpendicular to the screen by left-clicking and dragging the mouse on the *Graphic* window while holding down Shift.

The slab mode allows viewing a cross-section of specific groups, which is very useful for exploring the interior of proteins.

I. NON STEREOSCOPIC MODES

139 • Normal Display Mode

This is the default mode for Mac and Windows. It allows a rapid real time display and a high frame rate rendering. Therefore, it is the most suitable mode for straightforward work.

This mode lets you apply all DeepView commands, including all computing and fitting tools.

Under the *Preferences* menu (see point 167), you can adjust several options governing the appearance of molecules under normal display.

140 • 3D-Renderings

Two 3D-rendering types are available, which can be turned on and off by clicking *Display>Use OpenGL Rendering* and *Display>Render in solid 3D*, respectively.

Use OpenGL Rendering is the default display mode for Linux and Irix. Ribbons and molecular surfaces appear in solid 3D, whereas backbones and sidechains are shown as show wire frame (van der Waals and accessible surfaces are always dotted):

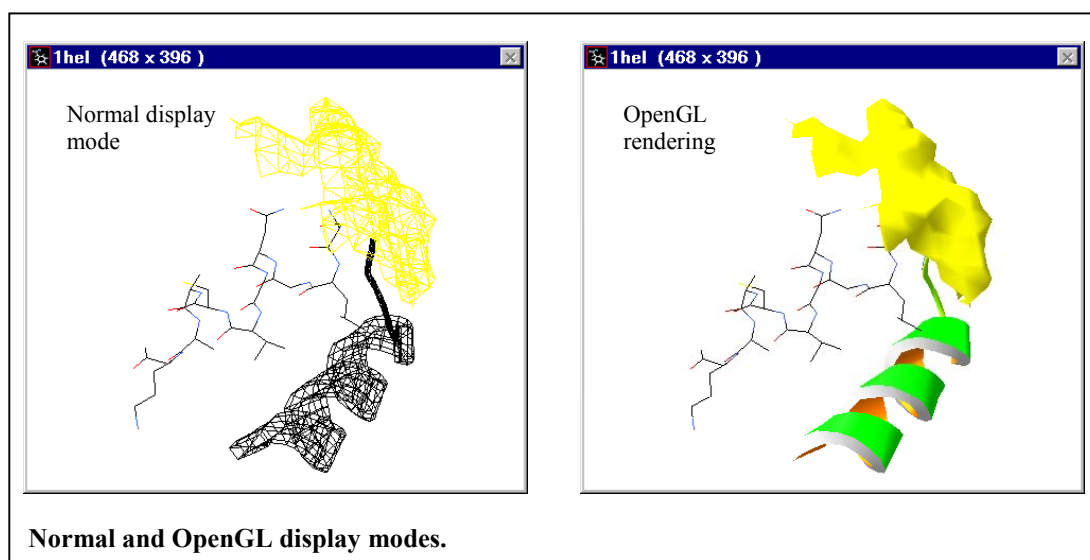

In addition, *Render in solid 3D* will generate solid backbones and sidechains:

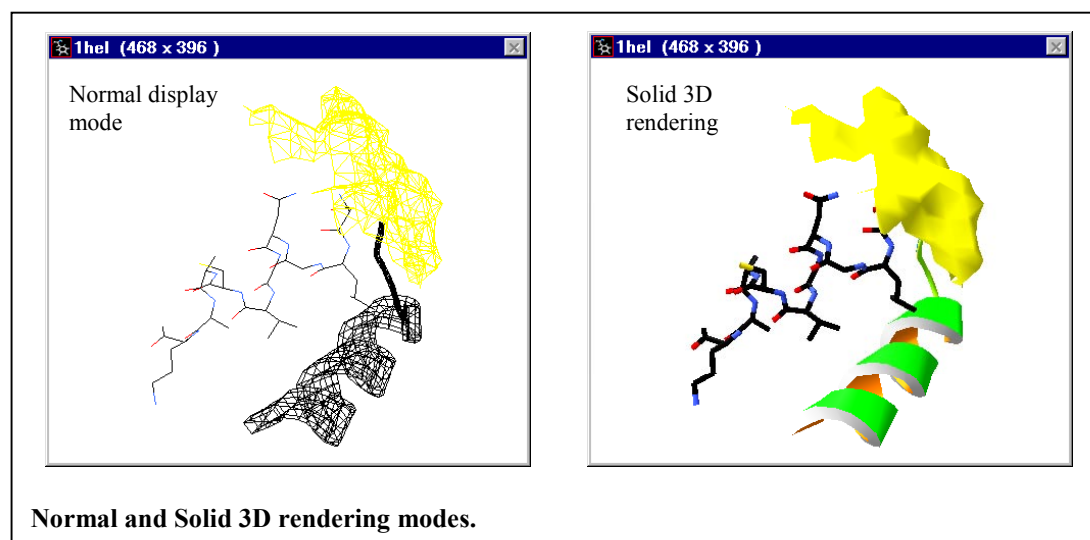

The appearance of the different solid objects can be altered under the *Preferences* menu:

Preferences>*Surfaces*: you can set the color, quality, and degree of transparency of molecular surfaces (see point 156)

Preferences>*Ribbons*: you can enable the solid 3D rendering of ribbons, and adjust their dimensions, shape, colors, and quality (see point 155),

Preferences>*3D Rendering*: you can set the dimensions, colors, and smoothness (quality) of bonds and atoms. Increasing the smoothness will divide the atoms (spheres) and bonds (cylinders) with more facets, improving the look of the image, but also dramatically increasing the rendering time (see point 165). (Note that these preferences are not for setting POV-Ray output, see point 141, *POV-Ray rendering*):

Smoothness	Number of facets used to describe one sphere	Number of facets used to describe one cylinder
1	8	10
2	18	14
3	32	18
4	72	22
5	162	26
6	200	30
7	288	34
8	450	38
9	648	42
10	800	46
11	1800	50
12	4050	54
13	7200	58

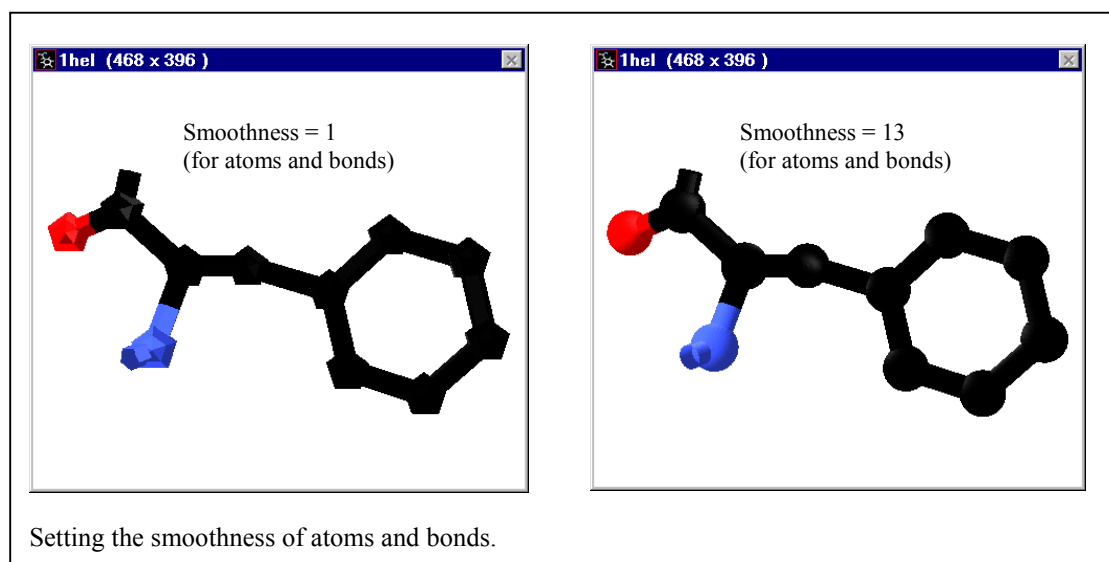

It might be a good idea to select a low smoothness to work on scenes, and increasing it once everything has been set-up. A high number of facets is actually not necessary to describe a good-looking sphere, provided that the *Use Meshes* option is enabled on the *3D Rendering Parameters* dialog.

Other 3D features that can be set under *Preferences*>*3D Renderings* include:

- the use of meshes for drawing solid objects: this will render nicer but slower images,
- the real time display of solid images.

Finally, click *Preferences>3D Light* to define the position and intensity of up to three sources of light to illuminate 3D renderings.

Current limitations of OpenGL 3D renderings on include:

Mac only: images appear in 256 colors on screen (but they will be always saved in millions of colors). You need to allocate enough RAM to the program so that the entire image (24 bits) can reside in RAM.

Images bigger than the screen cannot be rendered (for large images POV-Ray must be used).

141 • POV-Ray rendering

To obtain 3D images with a better quality, you can save your views to POV-Ray formatted files by clicking *File>Save>Pov3 Scene* or *File>Save>MegaPov scene* (same as *Pov3 Scene*, but with even smoother colors). You will get ray-traced quality images, which means that you will be able to add reflections, refractions, transparencies, and shadows to your view. As POV-Ray renders spheres and cylinders as mathematical objects, these will always be perfectly smooth, regardless of the smoothness settings that you had defined in the *Preference* menu.

(Linux and Irix: pressing the *Render* button will run POV-Ray and display the result, see point 33).

Have a look at Armand Tepper's homepage (Leiden University) for some really breathtaking examples: <http://wwwchem.leidenuniv.nl/metprot/armand/>

II. STEREOSCOPIC MODES

Click *Display>Stereo View*: this toggles the stereo view on and off.

Swiss-PdbViewer supports three distinct stereo modes: *red and blue*, *side by side*, and *hardware stereo*. *Red and blue* and *side by side* are supported on all machines, whereas *hardware* is only supported on machines equipped with hardware devices (e.g. *Stereographics CrystalEyes*, *NuVision*). Read carefully instructions given in ANNEX 3: HARDWARE REQUIREMENTS to prevent any damage to the screen.

Stereoscopic modes can be selected on the *Stereoscopic View Settings* dialog, which is displayed by clicking *Preferences>Stereo Display* (see point 168). The default mode is *Side by side*.

142 • Red and blue stereo

By default, a red and a blue overlapping images are displayed. The red image is rotated -2 degrees around the vertical axis, and the blue image is rotated +2 degrees:

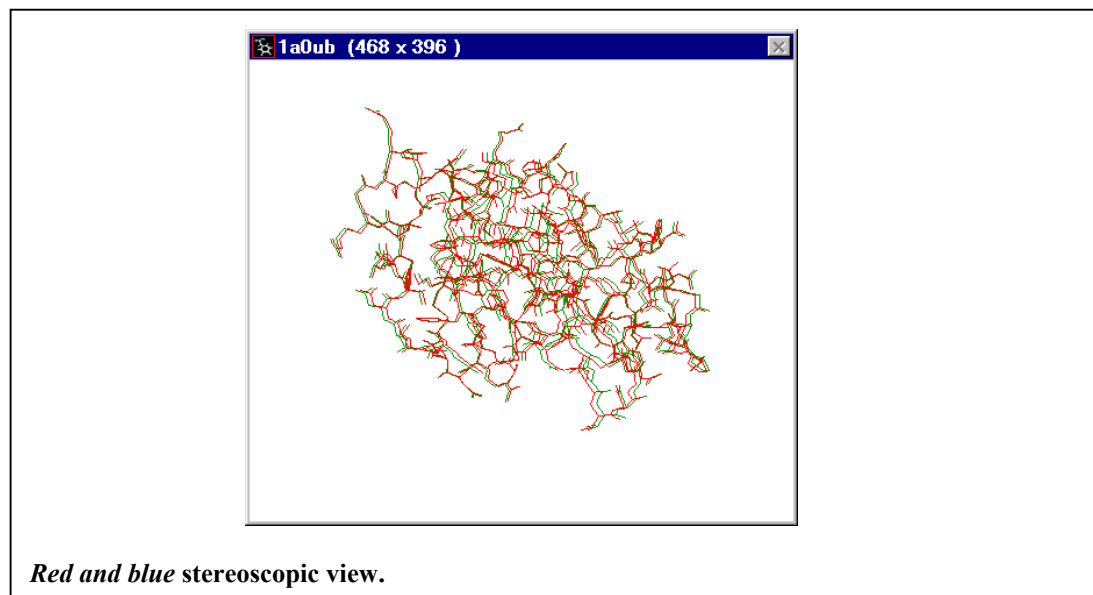

To see the molecule in real 3D, you simply need a pair of glasses with a red left glass and a blue right glass. If your glasses have other colors, you must adjust the displayed colors to your glass colors under *Preferences>Stereo Display*. The rotation angle between the two images ($2+2=4^\circ$ by default) can also be altered (see point 168).

143 • Side by side stereo

Two images are displayed side by side on the screen. The left image is the control image, on which you can click to select any object. By default, the left image is rotated -2 degrees around the vertical axis, and the right image $+2$ degrees:

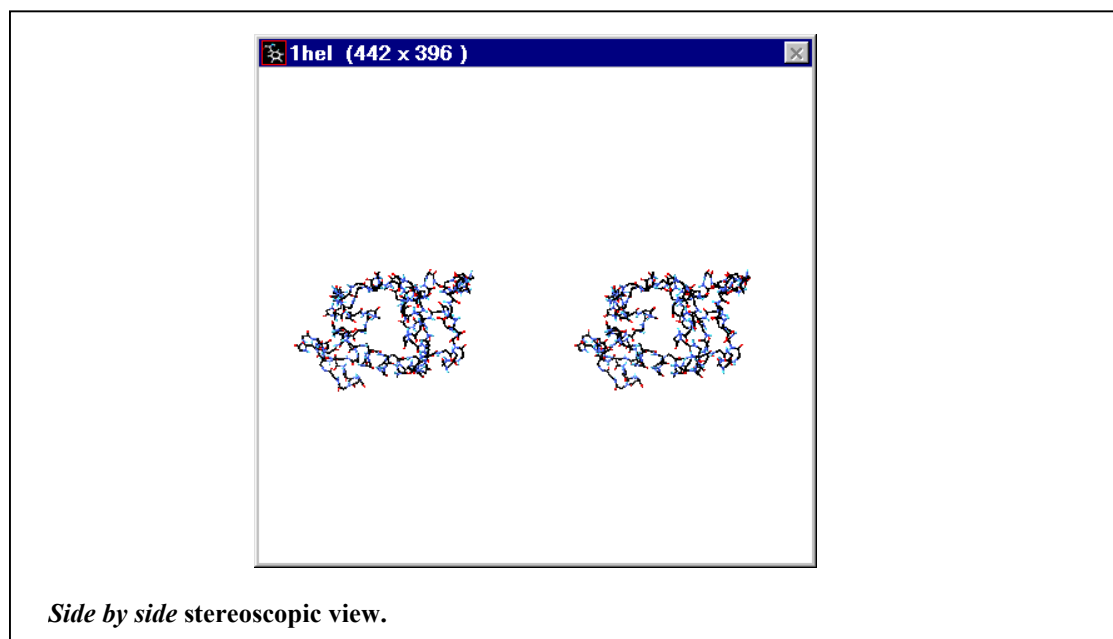

The principle of seeing in stereo is to look at the left image with the left eye, and to look at the right image with the right eye. As the two images are slightly rotated, each eye will see a slightly different side of the object and the brain will combine the two images into a 3D object.

Two factors, which can be adjusted on the *Stereoscopic View Settings* dialog (see point 168), affect the “side by side” stereo perception:

the separation, in pixels: the further apart the images are, the more difficult it is to maintain each eye aimed at the correct image. In 3D-rendering mode, each stereoscopic image is half the width of the *Graphic* window, and their separation cannot be adjusted on the *Stereoscopic View Settings* dialog. However, modifying the width of the *Graphic* window will affect the 3D-rendering stereo separation.

the rotation angle, in degrees: a negative rotation angle displays the left image at the right, and the right image at the left, which is referenced to as cross-eye stereo.

144 • Hardware stereo

Two modes of stereo hardware are available.

The first mode is Above/Below stereo (AB). In this mode, the screen is vertically divided into two parts (Above/Below). The left image is displayed on the top part of the screen, while the right image is displayed on the bottom part of the screen. A special hardware device is used to double the vertical synchronization of the screen, so that when the first half of the screen (left image) has been displayed, the electron beam goes back to the top of the screen and displays the bottom of the screen (the right

image). The result is that the left and right images are displayed in alternation on the screen at very high frequency. You can use special glasses (Crystal Eyes) with an LCD shutter that will alternately obscure the left or right eyes at the same frequency as images are displayed on screen. The result is that when the left image is displayed, the glasses will only let the light pass through the left eye, and when the right image is displayed, the left eye will be masked. The brain will reconstruct a 3D image from the two different images seen through each eye.

The second mode is true OpenGL Stereo in a window. This stereo mode takes advantage of the capability of OpenGL to support different screen buffers for left eye and right eye view. Switching between these views is done by the graphic card while sending the corresponding signal to the emitter, and this allows to see stereo in a normal window, while the rest of the desktop stays the same. This means that there is no loss of screen resolution or available screen space. This mode is much more convenient than Above/Below stereo format (AB), and is supported by most current stereo-ready applications on the market.

Not all graphic cards support true quad-buffered OpenGL Stereo, and drivers may be available only for some operating systems. Please check carefully with your hardware supplier before buying a card.

SETTING PREFERENCES

I. OVERVIEW

145 • Administering your preferences

The first block of commands under the *Preferences* menu is for administering your preferences:

<i>Preferences</i> menu	
Command	Action
<i>Modify Last Prefs. Dialog</i>	Recalls your last invoked <i>Preferences</i> command.
<i>Save Preferences as</i>	Lets you save in a *.prf file the state of all preferences of your current session
<i>Open Preferences</i>	Lets you open a *.prf file. This will contain the state of all preferences of a previous session, so that you do not have to re-enter them again.

146 • Default preferences

The first time you launch DeepView, a *Default.prf* file setting the most appropriate preferences for a smooth and rapid use of DeepView (default preferences state) is created and stored in the *usrstuff* directory. This file will be opened by default each time DeepView is launched. The *Default.prf* file is updated at each time a preference is changed.

Saving other states of preferences (that might be more proper for specific purposes, such as a white background) allows easily switching from one state to another, by simply opening the corresponding *.prf file.

147 • Resetting default preferences

To reset the preferences to their original default state:
close DeepView,
delete *Default.prf* from the *usrstuff* directory
restart DeepView.

148 • Setting preferences

Invoking the remaining 20 commands will display a dialog to let you set the following preferences:

<i>Preferences menu</i>		
Command	Set preferences	See point
<i>General</i>	Features displayed when initiating a DeepView session and upon loading a molecule.	149
<i>Loading Protein</i>	Appearance of molecules and default scaling for B-factor and RMS coloring.	150
<i>Real Time Display</i>	Appearance of molecules during displacements.	151
<i>Rock and Roll</i>	Speed and extent of automatic rotation around y-screen axis.	152
<i>Labels</i>	Appearance of labels.	153
<i>Colors</i>	Colors of molecules and background.	154
<i>Ribbons</i>	Appearance of ribbons.	155
<i>Surfaces</i>	Appearance and type of surfaces.	156
<i>Electrostatic Potential</i>	Methods and parameters used for electrostatic potential calculations.	157
<i>Electron Density Maps</i>	Appearance of Electron Density Maps.	158
<i>Energy Minimisation</i>	Methods and parameters used for energy minimisations.	159
<i>H-bond Detection. Threshold.</i>	Distance and angle constraints to detect H-bonds.	160
<i>Ramachandran</i>	<i>Ramachandran Plot</i> window features.	161
<i>Alignments</i>	<i>Alignment</i> window features.	162
<i>Swiss-Model</i>	Web address of Swiss-Model server.	163
<i>Network</i>	Web address of DeepView file server and local directory for importing files.	164
<i>3D Rendering</i>	Definition of 3D rendering parameters.	165
<i>3D Lights</i>	Definition of the position and intensity for three available 3D lights.	166
<i>Display</i>	<i>Graphic</i> window features, slab depth.	167
<i>Stereo Display</i>	Definition of stereoscopic view parameters.	168

II. SETTING PREFERENCES

Each *Preferences* dialogs comprises a series of items:

Items preceded with a square are for cumulative selections.

Items preceded with a circle are for selecting one amongst various exclusive options.

Text fields are for entering specific values of your own choice.

Clicking a *Color* button displays a standard color palette to let you choose a color for the associated item.

This chapter goes through all *Preferences* dialogs. Clarifications are limited to the most complex items, each dialog, being generally enough self-explanatory.

149 • General preferences

You can enable/disable the display of informative and warning messages, both on initiating a DeepView session and upon loading a molecule. You can also set how DeepView reads PDB files:

Check here to accept the preferences set appearance of the *Graphic* window, as set under *Preferences>Display* (see below),

Enable this item to get a report of problems found during loading molecules (missing atoms, etc).

Check the first item to be alerted when no CONNECT information is found on a PDB file. Check the second item to enable connection of residues with unusual bond length and enter a distance threshold for these connections.

Check these items to scale B-factors and/or RMS colors between their min and max values. Otherwise, a default fixed scale is applied for RMS values and B-factor values.

RMS: 0 < 2.5 < 5.0
 B-factor: 0 < 50 < 100
 Color: dark blue → green → red

150 • Loading preferences

Set here the default appearance of molecules, and enable some automatic processes when a protein is loaded. Note that a more advanced treatment can be envisaged by using the scripting language.

Checking here will only apply the preferences set in this dialog to non-Swiss-PdbViewer files, which include any PDB file not saved by Deep View.

Check here to filter all water molecules from the structure: they will not be displayed, nor loaded.

Check here to apply these processes to molecules upon loading (refer to points 116, 121, and 105, respectively).

Select a default coloring scheme for molecules upon loading.

151 • Real time display preferences

You can specify how much the display of molecules should be simplified while these are moved. The simpler the display and the “smoother” the handling of real-time translations, rotations and zooms. Thus, various options to reduce the CPU load are provided:

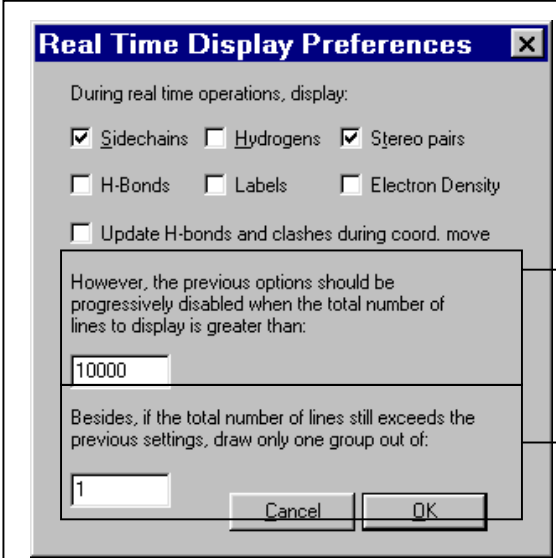

To allow a finer control of the CPU load, you can modify the maximum number of lines to draw. If the number of lines to draw exceeds this threshold value, the program will first attempt to draw the molecule without stereo view, then without hydrogen atoms, and eventually without sidechains.

In order to reduce even more the CPU load, you can allow the program to draw only one group out of n .

NOTE: the maximum number of lines that can be drawn during real-time operations is deliberately limited to 65000.

152 • Rock and Roll

By pressing >, DeepView animates molecules with a rolling motion around the vertical screen axis. This lets you perceive their 3D geometry under normal display (no stereoscopic view, no 3D rendering). The following dialog lets you set some parameters for the rolling motion:

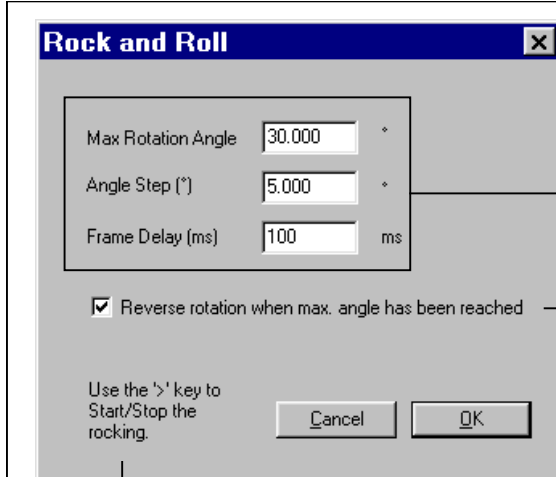

In this example, molecules will rock between $+30^\circ$ and -30° along the y screen axis, being on display during 100 ms every 5°.

Unchecking this option will annul the *Max Rotation Angle* set above, and the molecule will roll around 360° .

Information field: to stop rocking press Esc.

153 • Labels settings

Set the appearance of the labels that are displayed on the *Graphic* window by:
 using the *Control Panel* for naming amino acids,
 using the *Toolbar* tools for measuring distances and angles between atoms.

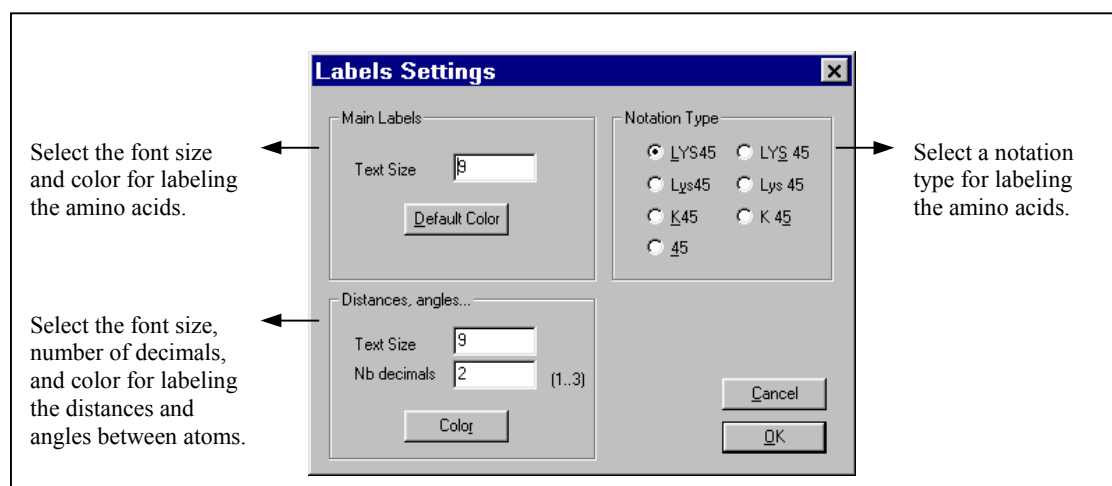

154 • Color settings

Set the colors of various objects by clicking the items of the following dialog, which will display a standard color palette to let you choose the colors:

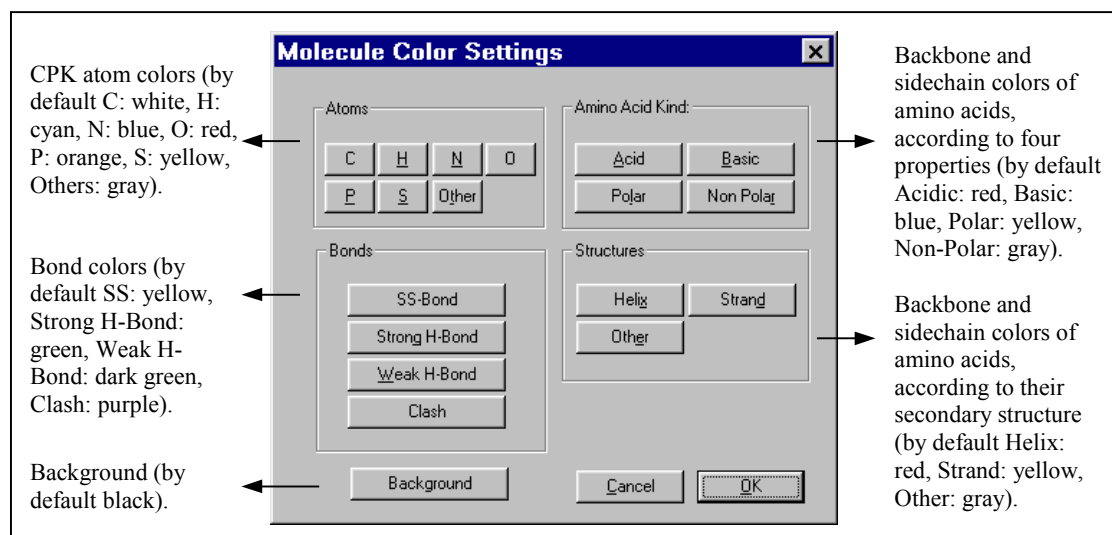

155 • Ribbon preferences

Set the appearance of ribbons on the *Graphic* window:

The **Ribbons Preferences** dialog box is shown with the following settings and annotations:

- nb Strands:** 3
- During Real Time Rotations:** 3
- Render as Solid ribbon** **also in real time** **Quality 1...2:** 1
- Helices:**
 - Width (Å):** 3.000 **Height (Å):** 1.000
 - Use this Top Use this Side Use this Bottom
 - Arrow at C-terminus **Width %:** 165.000 **Height %:** 100.000
 - Shape:** [radio buttons]
- Sheets:**
 - Width (Å):** 2.000 **Height (Å):** 0.500
 - Use this Top Use this Side Use this Bottom
 - Arrow at C-terminus **Width %:** 175.000 **Height %:** 100.000
 - Shape:** [radio buttons]
- Coils:**
 - Width (Å):** 0.400 **Height (Å):** 0.400
 - Use this Top Use this Side Use this Bottom
 - Shape:** [radio buttons]

Annotations:

- Fast display (non-solid): edit the nb of strands to represent the ribbons for static and moving molecules.
- 3D display: check here to enable the solid display of ribbons for static and moving molecules, and set the display quality (2 better than 1).
- For helices, sheets, and coils:
 - Edit their width and height (in Angstroms).
 - For 3D display only: check these items to use top, side, and bottom colors, which can be selected by clicking *Color*.
 - For 3D display only: select a section shape.
- For helices and sheets:
 - Check these items to enable representation of an arrow at C-terminus, and enter its width and height (as a percentage of the helix or strand width and height, as set above).

156 • Surface preferences

Set the appearance and color of molecular surfaces. (Van der Waals and accessible surfaces are always dotted, and that their color can only be modified on the *Control Panel*).

The **Surface Preferences** dialog box is shown with the following settings and annotations:

- General Appearance:**
 - Dotted Lines Plain Lines Filled Triangles (only in 3D mode)
- General Appearance (Real Time):**
 - Not drawn Dotted Lines Plain Lines Filled Triangles
- Quality [1..6]:** 1
- Transparency:** 0 (Transparency will show only on SGI or when the scene is rendered with POV)
- Default surface Color:**
 - Cavity Atom Type Electrostatic Potential
 - Ignore Selected Residues (for example cofactor)
 - Red:** -1.800 **White:** 0.000 **Blue:** 1.800

Annotations:

- Select a color for molecular surfaces. If you color them by their *Electrostatic Potential*, you need to compute it first and edit here the sigma values for the electrostatic potential.
- NOTE: Coloring a molecular surface by its electrostatic potential is equivalent to mapping the electrostatic potential to the surface (see next dialog).
- Select the general appearance of molecular surfaces, for static and moving molecules.
- Set the surface quality (1=coarser, 6=finer: affects the precision for detecting cavities, see point 102), and transparency (0=none, 100=full).
- Check here to compute a surface ignoring selected residues (useful to compute a surface for one chain only, for example).

157 • Electrostatic potential parameters

Set various options for computing electrostatic potentials. The same dialog is displayed when computing electrostatic potentials, as explained in point 103.

Electrostatic Potential

Parameters:

- Dielectric constant (solvent): 80.000
- use only charged residues
- use atomic partial charges

Computation Method:

- Coulomb
- Poisson-Boltzmann
- Dielectric constant (protein): 4.000
- Solvent Ionic Strength [mol/l]: 0.000
- update display every 20 cycles

Map Potential to Surface:

- Keep Map
- Red: -1.800
- White: 0.000
- Blue: 1.800

Buttons: Cancel, OK

Annotations:

- Select between using charged residues or atomic partial charges.
- Select a computation method.
- Enter the protein dielectric constant and the solvent ionic strength.
- Enter the solvent dielectric constant.
- Check *Keep Map* to display the electric field spreading out into the solvent.
- Check here to display the electric charge of the molecular surface (you must have computed it first).
- Enter the cutoff values of the electric charge (in kT/e) to set the color gradient:
 - 1.8 kT/e < 0.0 kT/e < 1.8 kT/e
 - red → white → blue (can also be entered in the *Surface Preferences*, see above).
- Computing electrostatic potentials requires several iterations: check this item to refresh the potential on the screen, which lets you see how the potential converges.

158 • Electron density maps (EDM) parameters

These settings affect 3D contouring of both electron density maps and electrostatic potential maps:

Electron Density Map Parameters

Infos

	X	Y	Z
Unit Cell Size (Å)	79.100	79.100	37.900
Cell Angles	90.000	90.000	90.000
Nb Sections	151	151	73
Min Section	-42	4	-11
Max Section	44	81	85

Display

- From Section: 25 to 3
- Around CA: 7.500
- Display only around Selected Residues: [slow!]

Contouring

- Contour a 1.000 sigma with Color Dotted
- Contour a 1.500 sigma with Color Dotted

Coarse Contouring Along

- X Y Z
- Draw Unit Cell

Buttons: Cancel, OK

Annotations:

- This field, which cannot be edited, provides information on the unit cell and on the loaded map:
 - unit cell size (Å) along a (X), b (Y), c (Z);
 - unit cell α , β , γ angles;
 - number of sections in which the cell is divided, along each axis.
 - range of sections (Min to Max) covered by the map, along each axis.
- Select the display of your EDM:
 - *From Section to Section*: limits a volume according to the number of sections that you enter.
 - *Around CA*: limits a volume around the centered aa, according to the distances that you enter for each axis.
 - *around Selected Residues*: the map is displayed around selected amino acids.
- You can enable the visualization of two contours and set their appearance: sigma values (see point 111 and annex XXX), color, and dotted vs. non-dotted.

Check these items for coarse contourings of electron density maps: their rendering will be speeded up to the detriment of their appearance (the information contained in one section out of two is skipped, giving a two-fold speed-up per coarse contouring enabled). This allows navigating in real time and interactively changing the sigma value (with the up and down arrow keys) for very large maps.

159 • E minimization preferences

Define here the energy minimization process:

Enable one, two, or three cycles of n steps of Steepest Descent (currently the only available energy minimization method).

Checkmark the interactions to be considered (see point 107).
Cutoff: enter a distance (Å) over which non-bonded and electrostatic interactions will not be considered.

Enter a value to stop minimization when checked option is verified.

Select between:
- *Lock non-selected residues*: only selected residues on the *Control Panel* will be minimized,
- *Use an harmonic constraint*: enter a force acting on selected and non-selected residues to adjust minimizations.
Option: restrict selected Lock or Constrain to CA only.

160 • H-bond detection threshold

Fix here the distances and angles between atoms to constrain H-bond detection (see point 101):

Edit here the H-bond detection threshold when H are present:
- min. H ---- H-Acceptor distance (1.20 Å by default),
- max. H ---- H-Acceptor distance (2.76 + 0.05 Å by default),
- H-Donor – H – H-Acceptor angle (120° by default).

Edit here the H-bonds detection threshold when H are absent.
- min. H-Donor---- H-Acceptor distance (2.35 Å by default),
- max. H-Donor---- H-Acceptor distance (3.20 + 0.05 Å by default),
- Any atom – H-Donor – H-Acceptor or H-Donor – H-Acceptor
- Any atom angles (90° by default).

161 • Ramachandran Plot preferences

You can set the display of the *Ramachandran Plot* window:

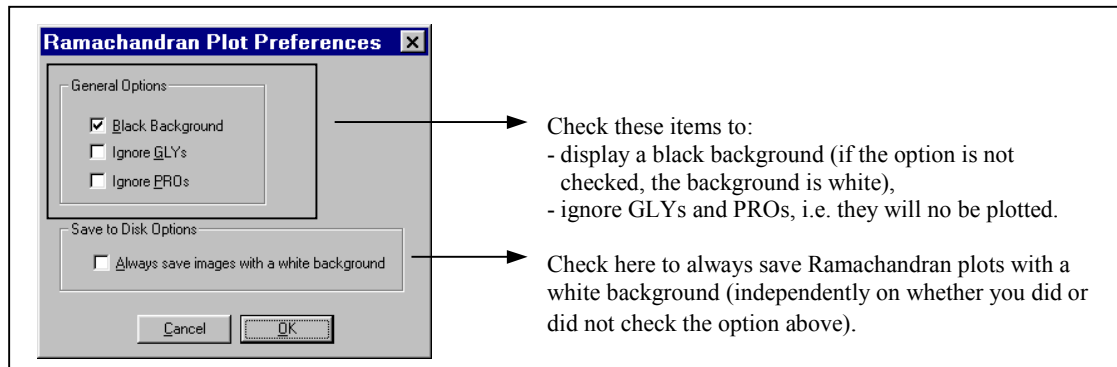

162 • Alignment window preferences

Set the display of the *Alignment* window and its associated *AlignPrv*.txt* file:

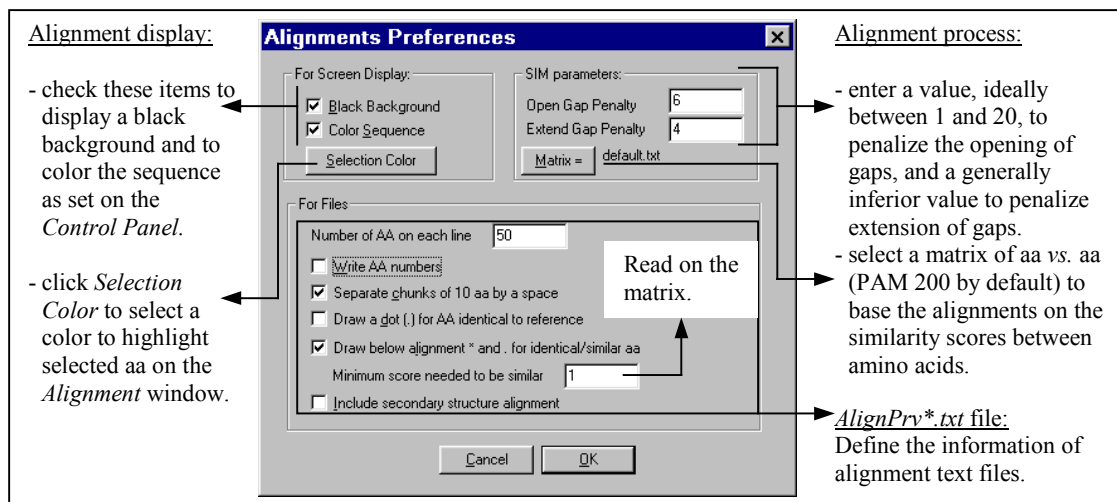

163 • Swiss-Model server settings

For using Swiss-Model you need to define the following servers:

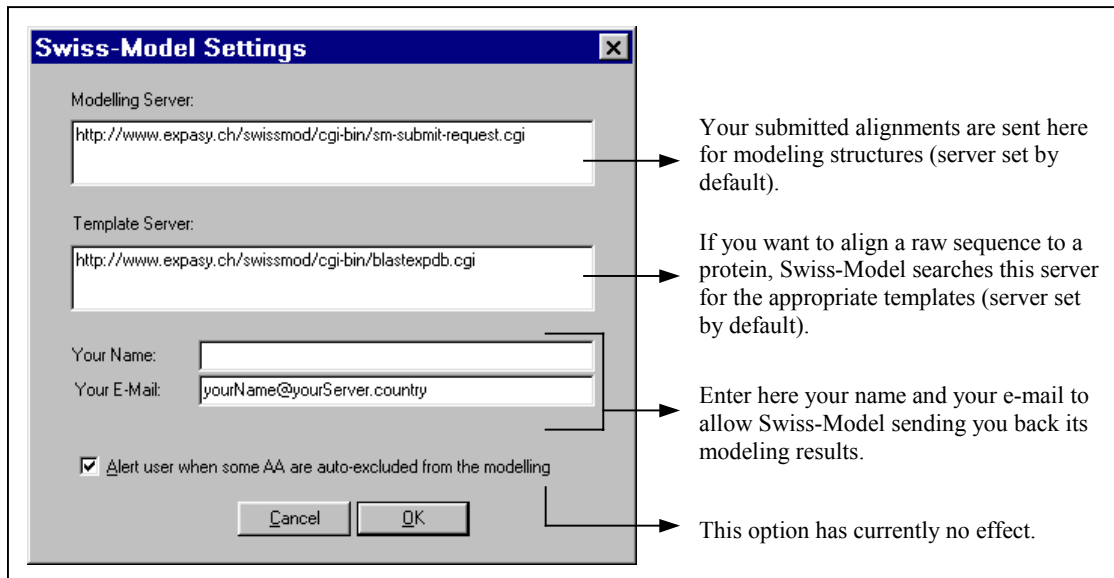

164 • DeepView file server settings

For using BLAST and importing PDB files, you must define the Web server:

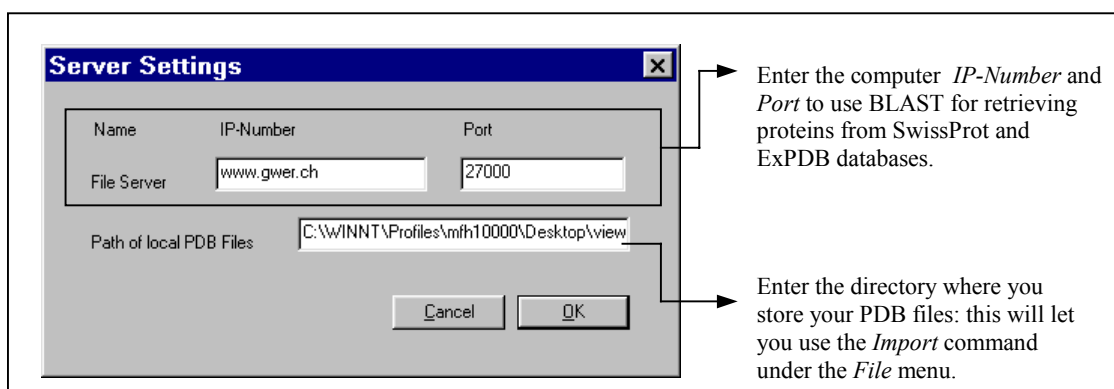

165 • 3D rendering parameters

Use this dialog to enter several parameters setting 3D renderings:

The screenshot shows the '3D rendering parameters' dialog box with the following settings and annotations:

- Render image:** Left eye, Standard, Right eye
- Use Meshes (nicer but slower), Stay solid during motion
- Bonds:**
 - Line width: 1.000 pixels
 - Radius (solid): 0.200 Å
 - H-bond radius: 0.075 Å
 - Smoothness (1..13): 2
 - Dotted H-bonds
- Atoms:**
 - Radius: 0.200 /30
 - Alpha Carbons size (relative to other C): 100 %
 - Atoms Smoothness (1..13): 2
 - Spacefilled atoms smoothness (1..13): 4
 - Show Atoms
 - same color as bonds for C atoms
 - and others
 - Keep atoms proportions by multiplying atom radius by 1.1 for H, 1.5 for N, 1.7 for C, 1.4 for O, 1.85 for S, ...
- Background Color:** [Button]
- Buttons:** [Cancel], [OK]

Annotations:

- Left side: "Edit these parameters for setting the visualization of bonds and atoms." (points to Bonds section)
- Left side: "Select a background color: this will apply to normal display also." (points to Background Color button)
- Right side: "General settings: - Left, Standard and Right eye: have currently no effects, - enable Use Meshes to smooth the image, - check Stay Solid during motion to enable a real time display." (points to top section)
- Right side: "Check Show Atoms to visualize atoms as spheres, and then select: Atom colors: if you colored your backbone by something else than by CPK, select same color as bonds for C atoms to apply the backbone color to all C atoms, and select and others to apply the same color to all atoms. Atom sizes: check Keep atom proportions to draw each kind of atom proportional to its size." (points to Atoms section)

166 • 3D light settings

You can enable the use of up to three sources of light to illuminate 3D images. For each source of light you can specify the following parameters:

The screenshot shows the 'Q3D lights' dialog box with the following settings and annotations:

- Enable Light 1
 - Position (Å): 20.000, 20.000, 20.000
 - Intensity: 1.000
 - Cast Shadows
- Enable Light 2
 - Position (Å): 0.000, 20.000, 20.000
 - Intensity: 0.500
 - Cast Shadows
- Enable Light 3
 - Position (Å): 20.000, 20.000, 20.000
 - Intensity: 0.500
 - Cast Shadows
- Buttons:** [Cancel], [OK]

Annotations:

- Right side: "- Position: distance (in Å) between the source of light and the center of the screen (coordinates (0,0,0)), along the X, Y, and Z axes." (points to Position fields)
- Right side: "- Intensity: light intensity, from 0 (no light) to 1. Higher values would saturate the colors." (points to Intensity fields)
- Right side: "- Cast Shadows: currently has no effect." (points to Cast Shadows checkboxes)

167 • Display window preferences

This dialog lets you set several parameters governing the normal and slab display of molecules on the *Graphic* window:

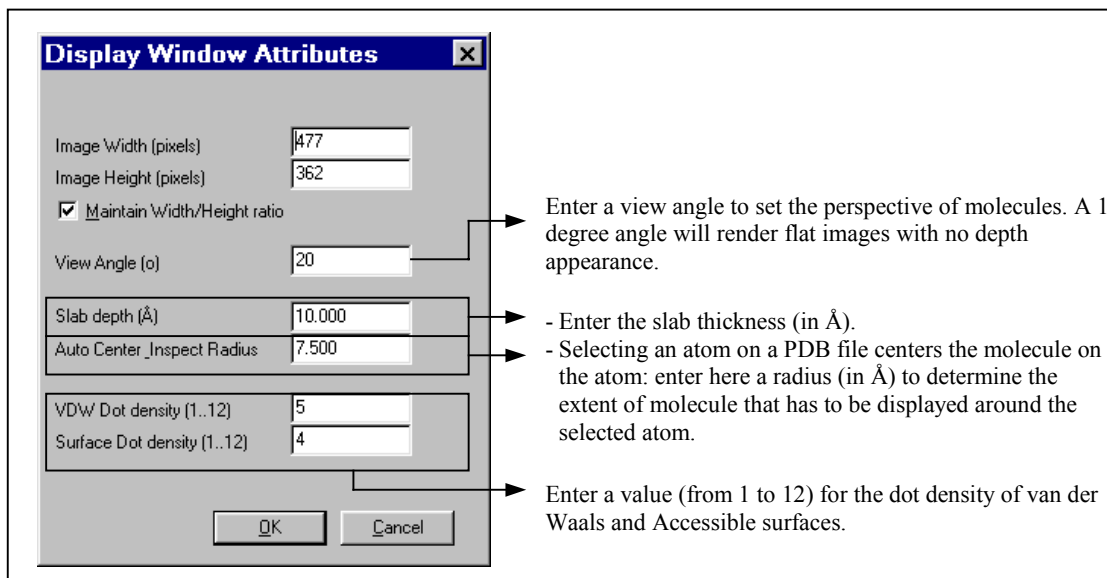

168 • Stereoscopic view settings

You can select one over four available stereo modes, and set several parameters governing the stereoscopic display of molecules on the *Graphic* window:

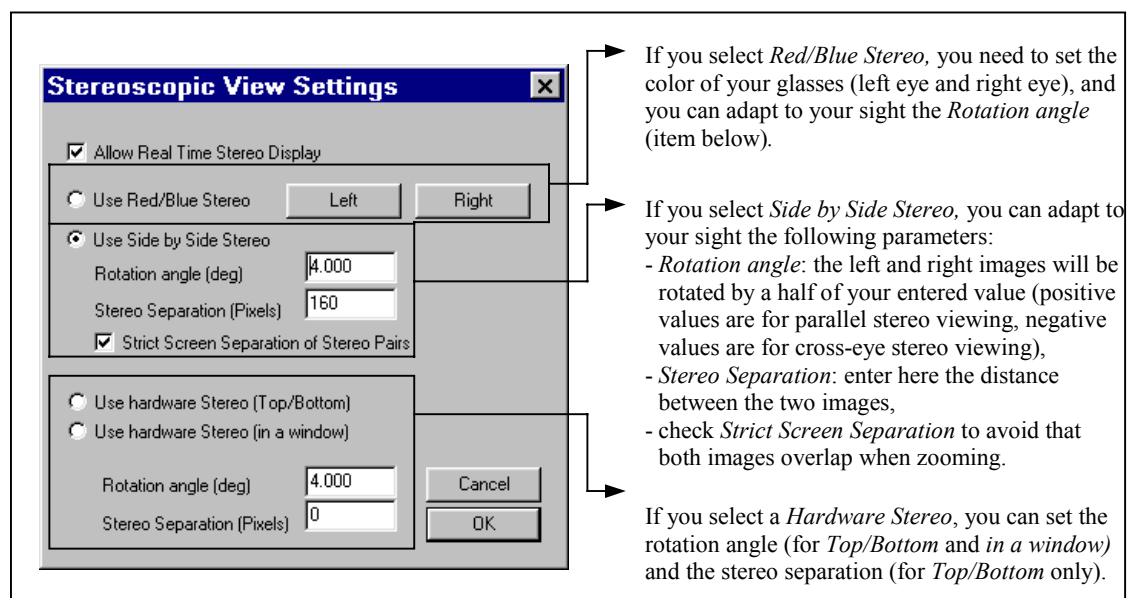

ANNEX 1: LIST OF KEY MODIFIERS AND MENUS

I. KEY MODIFIERS

*NOTE**:

Option key in Mac OS corresponds to right mouse in Windows.

Please, note that in this beta version, the keys and shortcuts will best match the user guide for the Mac version, not for the PC version. However, the Ctrl key is mapped to the right Alt key. The middle mouse button can be used to move the molecule, and the right mouse button can be used to zoom in/out.

Graphic window	
Action	Result
help or =(right mouse on PC)	Center and fit view to window
tab	Cycle through mouse actions: translate -- zoom – rotate
shift + tab	Cycle through mouse actions, reverse order
Esc	Turn off button actions (measurement, label)
control + drag	Limit rotate or translate to x-axis
option + drag	Limit rotate or translate to y-axis
command + drag	Limit rotate or translate to z-axis

Control Panel and Layer Infos window	
Action	Result
Click header	Add checkmark to selected, remove others
Click group name	Select group, deselect others
return	Show selected, hide others
enter	Turn on/off (toggle) selected, others not affected
control + click header	Add checkmark to selected, others not affected
control + click name	Select group, others not affected
control + return	Show selected, others not affected
shift + control + click on header	Remove checkmark from selected, others not affected
shift + control + return	Hide selected groups, others not affected
shift + click in column	Act on all columns
option + click group name*	Center group (and map)
option + click in h/s column*	Center group and select group plus its secondary structural element

Alignment window	
Action	Result
control + click group	Select group, others not affected
shift + click group	Select group in all layers

option + click group (PC: left mouse)	Center group (and map)
---------------------------------------	------------------------

Ramachandran Plot	
Action	Result
option + click group symbol*	Center group
9 (nine) + click and drag symbol	Change group phi only
0 (zero) + click and drag symbol	Change group psi only

Menus	
Action	Result
shift	Act on all layers
control + Select	Add to current selection

II. LIST OF MENUS

Select menu

Command	Subcommand	See section
None (Ctrl+0)		
All (Ctrl+A)		
Inverse Selection (Ctrl+I)		
Visible groups		
Pick on Screen		
Group Kind	[list of 20 aa]	
	[list of 6 nucleotids]	
	HETATM	
	Solvent	
	S-S Bond	
Group Property	Select Basic amino acids	
	Select Acidic amino acids	
	Select Polar amino acids	
	Select non Polar amino acids	
Secondary Structure	Helices	
	Strands	
	Coils	
	non-TRANS amino acids	
	aa with Phi/Psi out of Core Regions	
	aa with Phi/Psi out of Allowed Regions	
Accessible aa		
Groups with same Color as		
Extend to other Layers		
aa Identical to ref. Structure		
aa Similar to ref. Structure		
aa. Whose rmsd to ref. Structure is		
Neighbors of Selected aa		
Groups Close to an other Chain		
Groups Close to an other Layer		
aa Making Clashes		
aa Making Clashes with Backbone		
Sidechains lacking Proper H-Bonds		
Reconstructed amino acids		

Tools menu

Command	Subcommand	See section
Compute H-bonds		
Compute Molecular Surface		
Compute Electrostatic Potential		
Triangulate Map		
Compute Energy (Threading)		
Compute Energy (Force Field)		
Energy Minimization (Ctrl+N)		
Fix Selected Sidechains	Quick and Dirty	
	Exhaustive Search	
	Simulated Annealing	
Apply Transformation on Current Layer		
Build Crystallographic Symmetry		
Translate Layer along Unit Cell		
Detect Domains		
Detect Contact Surface		
Detect Secondary Structure		
Randomize Selected Groups		
Set Omega/Phi/Psi	Alpha Helix	
	Beta Sheet	
	Other	
Move C-term part during Phi/Psi Changes		

Display menu

Command	Subcommand	See section
Views	Save Delete Reset [change list by dialog]	
View From	Group Name	
Label Kind	Atom Name AtomType Atom Charge Atom Code (GROMOS) Clear User Labels	
Slab	(Alt+V)	
Stereo View	(Ctrl+T)	
Show Axis		
Show CA Trace Only		
Show Backbone Oxygens		
Show Sidechains even when Backbone is Hidden		
Show Dots Surface		
Show Forces		
Show Hydrogens	(Ctrl+H)	
Show H-bonds	(Ctrl+B)	
Show H-bonds distances		
Show Only H-bonds from selection		
Show Only groups with visible H-bonds		
Use Open GL Rendering	(Shift+Ctrl+3)	
Render in solid 3D	(Ctrl+3)	

Color menu

Command	Subcommand	See section
Act on [Selected Object]	Act on Backbone + Sidechains Act on Backbone Act on Sidechains Act on Ribbon Act on Label Act on Surface	
by CPK		
by Type		
by RMS		
by B-Factor		
by Secondary Structure		
by Secondary Structure Succession		
by Selection		
by Layer		
by Chain		
by Alignment Diversity		
by Accessibility		
by Threading Energy		
by Force Field Energy		
by Protein Problems		
by Other Color		
by Backbone Color		
by Sidechain Color		
by Ribbon Color		
by Surface Color		
by Label Color		

Build menu

Command	See section
Build Loop	
Scan Loop Database	
Find Best Fitting Peptides	
Break Backbone	
Ligate Backbone	
Add C-terminal Oxygen (OXT)	
Add Residue	
Add Bond	
Add H-Bond	
Add Hydrogens	
Add H2O	
Remove Selected Residues	
Remove Bond	
Remove H-Bond	
Remove Hydrogens (All)	
Remove Hydrogens (Non Polar)	

Fit menu

Command	See section
Fit Raw Sequence	
Magic Fit (Ctrl+M)	
Iterative Magic Fit (Shift+Ctrl+M)	
Explore Alternate Fits	
Fit molecules (from selection)	
Improve Fit	
Calculate RMS (Ctrl+D)	
Set Layer Std. Dev. into B-factors	
Generate Structural Alignment (Ctrl+G)	
Compress Gaps	
Reset Alignment	
Reset Orientation (current layer only)	
Reset Orientation (every layer follows)	

Preferences menu

Command	See section
Modify Last Pref. Dialog (Ctrl+Y)	
Open Preferences	
Save Preferences as	
General	
Loading Protein	
Real time Display	
Rock and Roll	
Labels	
Colors	
Ribbons	
Surfaces	
Electrostatic Potential	
Electron Density Map	
Energy Minimization	
H-bonds detection threshold	
Ramachandran	
Alignments	
Swiss-Model	
Network	
3D Rendering	
3D Lights	
Display	
Stereo Display	

Swiss-Model menu

Command	See section
Load Raw Sequence to Model	
Load FoldFit Alignment	
Save FoldFit Alignment	
Ignore Selected AA during modeling	
Use Selected AA during modeling	
Draw Residues to Ignore as	
Set current layer as reference	
Move raw sequence into structure	
Move structure into raw sequence	
Lock Selected Residues of Model	
Unlock Selected Residues of Model	
Homo Multimer Model	
Build Preliminary Model	
Save Optimize Model Job	
Update Threading Display Automatically	
Update Threading Display Now	
Auto Color by Threading Energy	
Find Appropriate ExPdb Templates	
Submit Modeling Request	

Window menu

Command	See section
Toolbar	(Alt+-)
Control Panel	(Alt+.)
Alignment	(Ctrl+L)
Layers Infos	(Ctrl+I)
Ramachandran Plot	(Ctrl+R)
Electron Density Map	(Shift+Ctrl+I)
Cavities [and Surfaces]	(Shift+Ctrl+T)
Link Toolbar and Graphic wind	
Text	(Alt+\$)
	C.II
	C.II

Help menu

Command	See section
About Swiss-PdbViewer	(Alt+?)
Update Swiss-PdbViewer	
Toolbar	
Control Panel	
Layers Infos	
EDM Window	
Alignment Window	
Ramachandran Plot Window	
WWW Manual	
Local Manual	
User Defined Links	
Check Y2K Compliance	
	C.IV
	C.IV

ANNEX 2: SCRIPTING LANGUAGE

I. USING SCRIPTS

- **Running scripts**

Scripts can be run with the *Run Script* item of the *File* menu, and loaded as text files with the *Open Text File* item of the *File* menu.

II. SCRIPTING LANGUAGE

- **Overview**

The parser of SPDBV scripting language has been generated with *flex* and *yacc*, whose combination allows building very advanced parsers. The scripting language will be quite familiar for persons who know *C* or *perl*.

The scripting language supports variables, conditional branching, loops, arrays and file access. Subroutines are also supported, but you must be aware that all variables are global. Despite this limitation, it allows to make the scripts more compact and readable, and can also be used to prepare a kind of "jump table" of your favorite functions that can be executed simply by clicking on their name from the SPDBV interface or from added menus.

The scripts can be stopped at specific points to let users interact with the graphical interface before resuming operation. This allows among other things to access commands not directly available from the script, take parameters from the user input, or execute other script commands not included in the script by typing them directly from the *Execute script command* item of the *Edit* menu.

On Unix systems, scripts can be passed as the last parameter of the command line (after optional PDB files). The place to post and exchange scripts is on the spdbv mailing list maintained by Prof. Gale Rhodes at <http://www.usm.maine.edu/~rhodes/SPVTut/text/DiscuSPV.html>.

As we all like to be polite, scripts must start with "please do" and end with "thank you". All instructions are terminated with a semicolon. All information following a # is ignored until the end of the line.

- **Data Types**

In the manual, data types appear between $\langle \rangle$. These means, that a value of the mentioned type is expected (or returned). This value can be obtained from a variable, or provided directly.

Supported types are:

Data type	Example
vector	<1.0,1.0,1.0>
float	1.0
int	42
string	"Hello World!"
layer	"1CRN" (alternately, layers can be referred to by position the first layer loaded is 0 the second 1, etc.
selection	select in <layer> pos <int> to <int>;
file	\$myfile = open file \$name;
internal variable	gCurrentOS

There are two types of variables: script variables (that can be used to store values in scripts) and program variables (internal spdbv variables).

Assigning a value to a script variable is done with:

\$varname = value

Data types for script variables are attributed implicitly during the assignment.

Examples:

\$X = 1.0; will assign the value 1.0 of type <float> to \$X.

\$X = 1; will assign the value 1 of type <int> to \$X.

Operations on variables are (usually) possible only between variables of the same type, but you can force a value to be of a different type through typecasting.

Example:

\$X = (float)1; will assign the value 1.0 of type <float> to \$X.

Valid typecast are:

(int) (float) (string)

• Arrays

Currently, only arrays of <int> <float> and <vector> are supported. The syntax is the following:

\$X[<int>] = value;

The type of array is automatically determined by the kind of value that you put into it the first time. Memory is allocated dynamically and will only be released when a 'thank you' statement is reached: if you want to get back something (memory), you better be polite ;-)

• Operations

It is possible to add, subtract, multiply or divide data types. Some operations are of course not possible (multiplying two strings or two atom selections).

Adding two strings will produce a concatenation.

\$X = "Hello" + " World!";

is equivalent to **\$X = "Hello World!";**

In the case of vectors, multiplication is scalar if one of the members is of type <float>:

\$X = <1.0,1.0,1.0> * 3.0;

will put <3.0,3.0,3.0> into \$X or performs a dot product if the operation involves two vectors.

The scalar product can be obtained with the 'X' operator:

\$X = <0.0,1.0,0.0> X <0.0,0.0,1.0>;

Floating point and integer variables can be pre/post incremented with ++<var> and <var>++ respectively, or pre/post decremented with --<var> and <var>-- respectively. This is mainly used for loops.

The remainder (modulo) of an integer division can be accessed by the % operator as in:

print 8 % 3;

which would give 2.

• Commands

Available commands are (alphabetically):

access acos angle align align_pos asin ask atan build center chain color compute clear close cos delete dist do else export fit get goto groupcount hide if inline is_selected layername max min minimize move mutate name normalize num omega open pause phi Pi "please do" print psi readln redraw rename renumber res rotate return rms save selcount select set show silent sin ss stop sub substring superpose system tan torsion "thank you" while zoom

NOTES:

- For version 3.7b1, some commands might not be implemented on all platforms. More commands will be added as needed.

- You can find several script examples in the *scripts* directory. Script examples are named script01.txt script02.txt etc. Scripts are designed to progressively introduce more and more features and an other way to learn this language is to study the scripts starting from script01.txt.

- All example scripts use the network import function to open pdb files. If you are working offline, you should copy the example files to your local disk, (e.g. the spdbv *usrstuff* directory) and change the example scripts accordingly: Instead of **open pdb from net "ICRN"** it should then look like **open pdb from usrstuff "ICRN.pdb"**.

• Tests (conditional execution)

```
if (expression test expression)
{
}
else
{
}
```

Where **test** can be:

```
= identity
!= different
> greater than
>= greater than or equal to
< smaller than
<= smaller than or equal to
```

Demonstrated in example script: 04, 06, and 08

• Loops

Two kinds of loops are supported that allow to cope with any situation. The higher level for(;;) statement is not implemented:

In the following case, statements will be executed at least once, and more depending on the result of the test.

```
do
{ <-- note that statements must start on the next line.
  statements;
}
```

```
while (expression test expression); <-- note the semicolon
```

In the following case, statements may not be executed at all, depending on the result of the test.

```
while (expression test expression)
{
  statements;
}
```

Demonstrated in example script: 01, 02, 03, 04, 05, 06, 07, and 09

● Internal variables

This is the list of recognized internal spdbv variables, that can be accessed by the **get** and **set** commands. Access to additional variables will be added in the future, as needed.

nbLayer: returns the position of the last layer as it starts at 0, when one layer is loaded its value is 0. Its value is 1 for two layers etc.
active_layer: returns the position of the currently active layer (the one shown in the *Control Panel*).
gDotDensity: changes the density of dots on van der Waals surfaces in normal display mode.
gCurrentOS: contains "MAC" "SGI" "LINUX" or "WINDOWS".

The following variables affect the behaviour of alerts presented during the load of a protein. It might be useful to disable them (set to 0) when a batch of files is to be treated:

gReconstructSidechain (0 or 1): reconstructs missing sidechains
gShowConnectAlert (0 or 1): reports missing or bad CONECT records
gShowHETATMAlert (0 or 1): reports ATOM treated as HETATM
gLoadWater (0 or 1): loads solvent molecules
gPartialOccupancyWarning (0 or 1): issues a warning when atoms have a partial occupancy, as defined in the PDB file.

Demonstrated in example script: 08 and 10

NOTE:

Access to other internal variables will be added in the future.

III. LIST OF COMMANDS

● access

Will get the relative accessibility of a residue X, compared to a 100% ref. value being computed in an extended conformation in the pentapeptide GGXGG. The returned value is of type <float>.

access(<selection>)

Alternately, you can access directly a specific residue from a specific layer, which is faster and handy in loops with:

access(<layer>,<int>)

Related commands: name res ss

Demonstrated in example script: 11

● acos

Computes the arc cosine of an expression. Values are in radians.

acos(<float>)

Related commands: sin asin cos tan atan PI

Demonstrated in example script: none

● angle

Computes the angle AOB between three atoms (vectors).

<floatvar> = angle(A,O,B);

where A,O and B are <vector> values. Result is returned in degrees.

Related commands: **dist get torsion**

Demonstrated in example script: **none**

● align

Will make a primary sequence alignment between layers.

align <layer> onto <layer>;

where <string> contains the question to be presented to the user.

Related commands: **align_pos**

Demonstrated in example script: **none**

● align_pos

Will get the position of a residue in an alignment (in the *Alignment* window). Returned value is of type <int>.

align_pos(<selection>)

Alternately, you can access directly a specific residue from a specific layer, which is faster and handy in loops with:

align_pos(<layer>,<int>)

Related commands: **"generate structural alignment" superpose rms fit**

Demonstrated in example script: **none**

● asin

Computes the arc sinus of an expression. Values are in radians.

asin(<float>)

Related commands: **sin cos acos tan atan PI**

Demonstrated in example script: **none**

● ask

Will make a dialog (yes, no) appear for user feedback.

\$int_varname = ask <string>;

where <string> contains the question to be presented to the user.

Related commands: **if**

Demonstrated in example script: **08 and 10**

● atan

Computes the arc tangent of an expression. Values are in radians.

atan(<float>)

Related commands: **sin asin cos acos tan atan PI**

Demonstrated in example script: **none**

● build

Adds various objects such as amino acids, molecular surface.

build in <layer> molecular surface of quality <int>;

Related commands: **delete**

Demonstrated in example script: **none**

● center

Centers the view on a selection or on visible groups.

center on <selection>;

center on visible;

Related commands: **show hide**

Demonstrated in example script: **05, 09, and 13**

● chain

Will get the chain name of the first selected group found in a selection. Returned value is of type <string>.

chain(<selection>)

Alternately, you can access directly a specific residue from a specific layer, which is faster and handy in loops with:

chain(<layer>,<int>)

Related commands: **name res ss access**

Demonstrated in example script: **11**

● color

Colors some parts of the view. This is functionally equivalent to the color column of the *Control Panel*.

color [in <layer>] <part> of <selection> by <vector>;

color <part> of <selection_variable> by <vector>;

color <part> of <selection_variable> in <color>;

when in <layer> is omitted, the currently active layer is assumed.

<part> can be any combination of **res side label surface ribbon vdw**.

<vector> is a RGB color (with intensity of each component are between 0.0 and 1.0).

<color> is any of the predefined keywords: red green blue yellow white black grey cyan orange purple

example: color in "1crn" ribbon of res "F","N" by <1.0,0.0,0.0>;

Related commands: **hide show**

Demonstrated in example script: **05 and 13**

● compute

Performs various computations on a protein.

compute in <layer> electrostatic potential using "[coulomb|pb]" with "[partial|full]" charges;

compute in <layer> hbond;

<floatvar> = compute in <layer> energy;

Related commands: **discard minimize**

Demonstrated in example script: **07 and 09**

- **clear**

Clears a file on disk. **** USEFUL but DANGEROUS ****

clear file <string>;

where <string> is a variable that contains a filename.

Related commands: **open close readln**

Demonstrated in example script: **none**

- **close**

Closes a layer or a file.

close <layer>;

close file <file>;

where <file> is a variable that contains a file previously open.

Related commands: **open clear readln**

Demonstrated in example script: **02, 03, and 04**

- **cos**

Computes the cosine of an expression. This returns the value in radians.

cos(<float>)

cos(<int>)

Related commands: **sin asin acos tan atan PI**

Demonstrated in example script: **none**

- **delete**

Deletes selected residues, or hydrogens from a layer.

delete <selection>;

delete in <layer> hydrogens;

delete in <layer> molecular surface;

delete in <layer> electrostatic potential;

Related commands: **build**

Demonstrated in example script: **none**

- **dist**

Computes the distance between two atoms (vectors).

<floatvar> = dist(<vector>,<vector>);

Related commands: **angle get torsion**

Demonstrated in example script: **07**

- **export**

This command allows saving images or POV-Ray scenes.

export image as <string>;

export stereo image as <string>;

export pov as <string> [and render];

where <string> contains the filename with full path.

Alternately, you can save the file in one of the predefined directories [usrstuff|download|temp] with the following command:

```
export pov in [usrstuff|download|temp] as <string> [and render];
```

See **save** for more explanations about path and filenames. Note that the **[and render]** option will open the file for rendering on Mac and PC, but will automatically launch pov on Unix boxes provided you save the scene in the *usrstuff* directory.

Related commands: **save**

Demonstrated in example script: **09**

• fit

This command is equivalent to the *Fit molecules (from selection)* command under the *Fit* menu.

```
fit <layer> onto <layer> using <string>;
```

where <string> contains the method to be used ("CA", "backbone", "all").

Related commands: **rms superpose**

Demonstrated in example script: **none**

• generate structural alignment

Generates a structural alignment. It is functionally equivalent to the *Generate Structural Alignment* command under the *Fit* menu.

```
fit <layer> onto <layer> using <string>;
```

```
generate structural alignment
```

Related commands: **rms superpose fit**

Demonstrated in example script: **none**

• get

Can access internal DeepView variables or atomic coordinates, retrieve amino acid sequences, or capture the current selection status of a specific layer (when modified directly from the graphical user interface).

```
$sel = get selection of <layer>;
```

```
$varname = get <internal variable>;
```

```
$vector_varname = get coord <string> of <selection>;
```

```
$string_varname = get seq of <selection>;
```

where <string> contains the 4 characters atom name (for. ex " CA ") and selection a selection.

. The list of internal variables that can be accessed is given in section B of this annex.

Related commands: **set**

Demonstrated in example script: **07, 08, 09, and 10**

• goto

One of the most useful (and controversial) commands, that allows to continue the execution from a different point of the script.

```
goto <label>;
```

Execution will continue immediately after <label>, which must end with a colon.

Example:

```
goto elsewhere;  
print "Never done";  
elsewhere: print "welcome";
```

Related commands: **sub do while return**
Demonstrated in example script: **none**

● **groupcount**

Will return the number of groups in a layer. This is functionally equivalent to a select all followed by a **selcount**, although it is quicker.

```
$int_varname = groupcount of <layer>;
```

Related commands: **selcount**
Demonstrated in example script: **02, 03, and 04**

● **hide**

Hides some parts from the view. This is functionally equivalent to unchecking the *show* column on the *Control Panel*.

```
hide <part> of <selection>;  
hide in <layer> <part> of <selection>;
```

where <part> can be any combination of **res, side, label,s surface, ribbon, vdw**.

Related commands: **show color**
Demonstrated in example script: **06**

● **inline>** **text** **<inline**

This is used in conjunction with the open command to load PDB files directly embedded in the script, which is useful mostly for web servers that need to return a script+pdb file in a single file.

```
open pdb INLINE>  
ATOM      1  N   THR      1   17.047  14.099   3.625  1.00  13.79  
ATOM      2  CA  THR      1   16.967  12.784   4.338  1.00  10.80  
ATOM      3  C   THR      1   15.685  12.755   5.133  1.00   9.19  
ATOM      4  O   THR      1   15.268  13.825   5.594  1.00   9.85  
ATOM      5  CB  THR      1   18.170  12.703   5.337  1.00  13.02  
ATOM      6  OG1 THR      1   19.334  12.829   4.463  1.00  15.06  
ATOM      7  CG2 THR      1   18.150  11.546   6.304  1.00  14.23  
<INLINE;
```

Related commands: **open**
Demonstrated in example script: **none**

● **is_selected**

Checks if a specific residue is selected.

```
is_selected(<layer>,<int>)  
is_selected(<int>)
```

When <layer> is omitted, the current active layer is used. Returned value is of type <int> and is 1 if the group is selected and 0 otherwise.

Related commands: **select**

Demonstrated in example script: 11

● **layername**

Will return the <string> value of the layer name

<string_var> = layername of <int>;

where **int** is the relative position of the layer from the first loaded which is number 0, of course.

Related commands: none

Demonstrated in example script: none

● **max**

Will return the max value of two numbers or variables.

max of (<float>,<float>);

max of (<int>,<int>);

Related commands: min

Demonstrated in example script: none

● **min**

Will return the min value of two numbers or variables.

min of (<float>,<float>);

min of (<int>,<int>);

Related commands: max

Demonstrated in example script: none

● **minimize**

Performs an energy minimisation using n cycles of steepest descent

minimize <selection> of <layer> with <int> cycles;

Related commands: compute

Demonstrated in example script: 07

● **move**

Moves a selection.

move <selection> by <vector>;

where <vector> contains the translation in angstroms.

Related commands: zoom rotate

Demonstrated in example script: 09

● **mutate**

Will mutate an amino acid to another. It is currently not possible to browse the rotamer library in a script.

mutate <selection> to <string>;

where <selection> must contain one valid amino acid (first selected is taken) and <string> contains the one letter code of the new residue.

Related commands: **none**

Demonstrated in example script: **none**

● **name**

Will get the three letter name of the first selected group found in a selection. Returned value is of type <string> for ex: is 'ALA' or 'ATP'.

name(<selection>)

Alternately, you can access directly a specific residue from a specific layer, which is faster and handy in loops with:

name(<layer>,<int>)

Related commands: **num res chain ss access**

Demonstrated in example script: **11**

● **normalize**

Will normalize a vector. Returned value is of type <vector>.

normalize(<vector>)

Related commands: **vector operations.**

Demonstrated in example script: **none**

● **num**

Will get the number of the first selected group found in a selection. Returned value is of type <int>.

num(<selection>)

Alternately, you can access directly a specific residue from a specific layer, which is faster and handy in loops with:

num(<layer>,<int>)

Related commands: **name res chain ss access**

Demonstrated in example script: **11**

● **omega**

Will get the omega peptidic bond torsion angle for the first selected amino acid found in a selection. Returned value is of type <float> and is returned in degrees.

omega(<selection>)

Alternately, you can access directly a specific residue from a specific layer, which is faster and handy in loops with:

omega(<layer>,<int>)

Related commands: **phi psi ss**

Demonstrated in example script: **none**

● **open**

Loads a pdb file in the workspace (next available layer).

open [pdb] from "disk|net" <string>;

To be able to use the "net" option, you have to set the correct server address in "Network Preferences". Note that it is possible to omit "pdb" as it is the default value. <string> contains the full filename (see below). The filename must be the absolute path of your file. Unix users will understand what I mean, but Mac users might be a little confused.

Alternately, to be cross platform, you can also use one of the predetermined directories:

```
open [pdb] from usrstuff <string>;
open [pdb] from temp <string>;
open [pdb] from download <string>;
```

Constructing a full path on a Mac:

name_of_disk:name_of_folder:name_of_subfolder:name_of_subsubfolder:filename

For example, assume you store your pdb files in a folder named 'pdb' located in the 'System' disk. You can access the file 'lcrn.pdb' like this:

```
System:pdb:lcrn.pdb
```

As you can see, Mac uses ':' as separator. This is of course different for Unix which uses '/' and from windows which uses '\'. In order to make your scripts as portable as possible, I would recommend separating the file name from the path, which will let you (or other users) change just the path (one line) to make a generic script run on their machine.

Consider this example:

```
open "System:pdb:lcrn.pdb";
```

```
open "System:pdb:lntp.pdb";
```

it is better rewrote like this:

```
$path = "System:pdb:"; # change this line to point to your pdb files directory.
```

```
open $path + "lcrn.pdb";
```

```
open $path + "lntp.pdb";
```

The "open" command also allows to create files or open arbitrary text files for further processing, or allows to open a file as read-only.

```
$file_varname = open file <string>;
```

```
$file_varname = open file <string> for reading;
```

or allows to open a file as write (** CAUTION when USING THIS **).

```
$file_varname = open file <string> for writing;
```

or allows to append to a file (** CAUTION when USING THIS **).

```
$file_varname = open file <string> for appending;
```

In fact, using the full path of your file (directories+filename) is potentially dangerous if for some reason the filename get screwed up. Besides, it is not cross-platform and you likely wish to have your scripts running everywhere, I suggest that you and work with files store the files in your *usrstuff* directory using the following equivalent commands:

```
$file_varname = open file <string> in usrstuff;
```

```
$file_varname = open file <string> in usrstuff for reading;
```

```
$file_varname = open file <string> in usrstuff for writing;
```

```
$file_varname = open file <string> in usrstuff for appending;
```

where <string> must ***ONLY*** contain the file name (no directory, no path).

The open command can also be used to open a text file, which is only useful coupled with the graphical user interface.

```
open text <string>;
```

```
open text <string> in usrstuff;
```

```
open seq <string>;
```

this can be used to load a target sequence to model. Sequence must be in format FASTA, SWISSPROT or SEQRES.

Related commands: **close clear readln inline print save**

Demonstrated in example script: **all**

- **pause**

Will stop the script execution for some seconds.

pause <float>;

Related commands: **stop “thank you” “please do”**

Demonstrated in example script: **05, 06, 07, and 09**

- **phi**

Will get the phi torsion angle for the first selected amino acid found in a selection. Returned value is of type <float> and is returned in degrees.

phi(<selection>)

Alternately, you can access directly a specific residue from a specific layer, which is faster and handy in loops with:

phi(<layer>,<int>)

Related commands: **psi omega as**

Demonstrated in example script: **01, 02, 03, and 04**

- **PI**

Returns the value of PI.

Related commands: **sin asin cos acos tan atan**

Demonstrated in example script: **none**

- **please do**

Initiates a script, and resets all scripts variables. Note that this statement must be on the FIRST line of the script.

Related commands: **stop pause “thank you”**

Demonstrated in example script: **all**

- **print**

Prints a value (string, variable, number etc.) onto stdout or in a DeepView communication dialog.

print on dialog; print on stdout;

print on <file> <expression>;

print <expression>;

where expression is any combination of arithmetic values or concatenation of strings. Note that a new line is printed after each print operation. You might then need to prepare a string (from concatenation) before printing.

Demonstrated in example script: **01, 02, 03, 04, 06, 07, 08, 11**

- **psi**

Will get the psi torsion angle for the first selected amino acid found in a selection. Returned value is of type <float> and is returned in degrees.

psi(<selection>)

Alternately, you can access directly a specific residue from a specific layer, which is faster and handy in loops with:

psi(<layer>,<int>)

Related commands: **phi omega**

Demonstrated in example script: **03** and **04**

● readln

Reads the next line from a text file or from a dialog box.

\$string_varname = readln from file <file>;

\$string_varname = readln from user <string>;

where <file> is a file previously open with the open file command. and <string> is a prompt that will appear in the dialog.

Related commands: **open close clear substring**

Demonstrated in example script: **04** and **06**

● redraw

Will force the main window to be refreshed. Only useful in the interactive mode.

superpose "1bhp" onto "1crn" using "CA";

redraw;

Related commands: **show**

Demonstrated in example script: **05** and **07**

● rename

Will change the chain name of the selected residues

rename chain of <selection> as <string>;

Will change the layer name

rename <layer> as <string>;

Related commands: **renumber**

Demonstrated in example script: **none**

● renumber

Will change the residue number of selected residues

renumber <selection> from <int>;

renumber <selection> add <int>;

Related commands: **rename**

Demonstrated in example script: **none**

● res

Will get the one letter name of the first selected group found in a selection. Returned value is of type <string> e.g.: 'A' or 'C' or 'D',...

res(<selection>)

Alternately, you can access directly a specific residue from a specific layer, which is faster and handy in loops with:

res(<layer>,<int>)

Related commands: **num name chain ss access**

Demonstrated in example script: 11

● rotate

Rotates the view successively around axis x,y,z:

rotate <vector>;

where <vector> contains rotation angles in degrees.

This command can also be used to rotate a selection around a specific axis.

rotate <selection> by <float> [deg|rad] around axis <vector> <vector>;

or to do a torsion (rotate atoms downstream a bond around this bond) using the following syntax:

rotate atoms of <selection> by <float> [deg|rad] around bond <string> <string>;

Related commands: zoo move

Demonstrated in example script: 05, 06, and 09

● return

Will resume execution where it was before entering the subroutine. See **sub** for more explanations.

Related commands: goto do while sub

Demonstrated in example script: 08 and 10

● rms

This command is equivalent to the *Calculate RMS* command under the *Fit* menu.

rms of <layer> and <layer> using <string>;

<floatvar> = rms of <layer> and <layer> using <string>;

where <string> contains the method to be used ("CA", "backbone", "all").

Related commands: fit superpose

Demonstrated in example script: 05

● ave

Saves all or part of pdb files from some layers.

save <layer> as <string>;

save selection of <layer> as <string>;

where <string> contains the full filename (see discussion in open).

An alternative set of commands that will save files in predefined directories located under the spdbv main directory is available. Directories can be *usrstuff*, *temp* or *download*:

save <layer> as <string> in [usrstuff|temp|download];

save selection of <layer> as <string> in [usrstuff|temp|download];

in this case <string> must contain ***ONLY*** the filename, as the directory is implicit. This is very useful to make scripts portable among the various OS supported (Windows, Mac, Irix and Linux).

Related commands: open

Demonstrated in example script: 06

● search

Allows searching 3D patterns in pdb files. **** NOT yet AVAILABLE ****

```
search in <layer> <string>;
search in <layer> <string> >> <string>;
```

where the first <string> contains the filename of the 3Dsearch pattern description file, and the second (optional) string appends the output to a file (that might be worth clearing before with the clear command).

Demonstrated in example script: none

● selcount

Will return the number of selected groups in a layer.

```
$int_varname = selcount of <layer>;
```

Related commands: groupcount

Demonstrated in example script: 06

● select

Allows selecting specific residues and performing logical operations on them. This can then be used to color or hide residues, among other things.

```
<var> = select [in <layer>] <selection>;
select <var>;
```

when [in <layer>] is omitted, the current active layer is assumed. <var> must contain a selection and <selection> can be any combination of:

all

None

Water hoh solvent h2o

Strand

Helix

Het

will select all HETATM

Aa

will select all amino acids

nt

will select all nucleotides

Res <string>

residue kind example: res "A", "C", "D"

Name <string>

residue name example: res "ALA", "OXT", "ATP"

Chain <string>

residue chain example: chain "A", " "

Num <int>

residue number

Pos <int>

residue absolute position in layer (start at 0).

Pos <int> to <int>

residue range absolute position in layer (start at 0).

Seq <string>

a sequence (can be a prosite pattern).

Within <float> of <selection_var>

Example:

```
$sel1 = select in "1ATP" res "Y" and chain "I";
```

It is currently not possible to provide very complex selections in one operation, but this is easily overcome as selections can be added or subtracted.

Example:

```
$sel = $sel1 + $sel2 + sel3 - sel4;
```

A special case allows to get the current selection state of a layer into a variable. This is useful to capture a selection made directly from the user graphical interface.

```
$sel = get selection of <layer>;
```

Related commands: selcount

Demonstrated in example script: all

- **set**

Can set DeepView internal variables or atomic coordinates. The list of internal variables that can be accessed is given in section B of this annex.

set <internal variable> = \$varname;

set coord <string> of <selection> = \$vector_varname;

where <string> contains the 4 characters atom name (for. ex " CA ") and selection a selection.

It also allows to toggle the backbone representation for a layer to "ca_trace":

set ca_trace [ON|OFF] for <layer>;

Related commands: **get**

Demonstrated in example script: **07**

- **show**

Shows some parts from the view. This is functionally equivalent to checking the *show* column of the *Control Panel*.

show <part> of <selection>;

show in <layer> <part> of <selection>;

where <part> can be any combination of **res, side, label, surface, ribbon, vdw**.

Related commands: **hide color**

Demonstrated in example script: **06, 09, and 13**

- **silent**

Can be used in conjunction with the stop command to prevent any feedback of which line the script was stopped.

silent stop;

Related commands: **stop**

Demonstrated in example script: **08 and 10**

- **sin**

Computes the sinus of an expression.

sin(<float>) sin(<int>)

This returns the value in radians.

Related commands: **asin cos acos tan atan PI**

Demonstrated in example script: **none**

- **ss**

Will get the secondary structure assignment of the first selected amino acid found in a selection. Returned value is of type <string> and is 'h' 's' or 'c'.

ss(<selection>)

Alternately, you can access directly a specific residue from a specific layer, which is faster and handy in loops with:

ss(<layer>,<int>)

Related commands: **phi psi omega**

Demonstrated in example script: 11

• stop

Will stop the script in a way that it can be continued from the graphical user interface with "shift" open script. Very convenient if you want to interactively inspect a molecule before resuming the script flow.

```
sub select_negative;
silent stop;
```

Related commands: “please do” “thank you” pause silent

Demonstrated in example script: 06, 08

• sub

This command is nothing else than a **goto** that remembers where it was before. It will resume execution where it was before entering the subroutine as soon as a return statement is reached.

```
sub <label>; <--- note that this must be the only command on a line
```

Execution will continue immediately after <label>, which must end with a colon.

Note that subroutines must be located at the end of the script (after the thank you statement). All variables being global, be very careful when you use them, especially loops variables).

Example:

```
please do
sub elsewhere;
thank you
```

```
elsewhere:
```

```
{
  print "Is grass really greener here?";
  return;
}
```

Related commands: goto do while return

Demonstrated in example script: 08 and 10

• substring

Allows accessing substrings within a string by position. Substrings are separated by spaces and numbering start from 0.

```
$string_varname = substring <int> of <string>;
```

Examples:

```
$X = substring 0 of "Hello World!"; will put "Hello" into $X.
```

```
$X = substring 1 of "Hello World!"; will put "World!" into $X.
```

Demonstrated in example script: 04

• superpose

This command is equivalent to the *Fit>Magic Fit* of spdbv.

```
<int> = superpose <layer> onto <layer> using <string>;
```

where <string> contains the method to be used ("CA", "backbone", "all", "ss"). This returns the number of solutions as an int.

When "ss" is used, and more than one solution is possible, a temp file "match.txt" is written and a window will be opened with one solution per line.

Related commands: **rms fit**

Demonstrated in example script: **05**

● **system**

Executes a shell system command. **** USEFUL but DANGEROUS ****.

system <string>;

This command is supported only for SGI and Linux versions. It is mainly useful to execute a script that will put results into a file that can then be open as read-only with the open file command and read line by line with **readln**.

Demonstrated in example script: **none**

● **tan**

Computes the tangent of an expression. Returns the value in radians.

tan(<float>)

tan(<int>)

Related commands: **sin asin cos acos atan PI**

Demonstrated in example script: **none**

● **torsion**

Computes the torsion angle ABCD between four atoms (vectors). In other words, the angle between planes ABC and BCD.

<floatvar> = torsion(A,B,C,D);

where A,B,C and D are <vector> values. Result is returned in degrees.

Related commands: **dist get**

Demonstrated in example script: **none**

● **thank you**

Polite way of ending a script, which will also free any memory assigned for arrays.

Related commands: **"please do"**

Demonstrated in example script: **all**

● **zoom**

This command changes the camera position to zoom in or out

zoom <float>;

where <float> is the percent change. 100.0 means no change, 110.0 will do a close-up (enlarge the image by 10%) 90.0 will zoom out (decrease the image size by 10%).

Related commands: **rotate move**

Demonstrated in example script: **05**

Annex 3: Hardware Requirements

• Hardware Stereo Support

DeepView – Swiss-PdbViewer currently supports the following hardware stereo display modes:

	Real OpenGL (quad buffered)	Above-below (AB) (frequency doubling)
PC (Win)	☺	☹
Macintosh		☹
SGI		☹
Linux		☹

Quad-buffered OpenGL Stereo ☺

We highly recommend to buy a stereo card that supports quad buffered OpenGL stereo, if available for your operating system. Please see with your hardware dealer. As a starting point, see e.g.:

Stereo Hardware:

<http://www.stereographics.com>

<http://www.nuvision3d.com/>

Graphic Cards:

<http://www.3dlabs.com/>

<http://www.ati.com/>

Above-Below (AB) stereo mode.

The AB hardware stereo mode needs a monitor capable of supporting a vertical synchronization that has been doubled. Other monitors might fuse when doubling of frequency is enabled. Make sure that you can switch your screen to a 120 Hz refresh rate before buying such hardware. This should be true for most of the multi-synch monitors, but is definitely not the case for old fixed frequency monitors. Also, consider that the effective resolution of the screen will be halved, so a 19" screen is quite recommended.

All graphic cards will work, as all switching is done by the external hardware. You will also need an emitter and LCD shutter glasses (e.g. CrystalEyes).

Macintosh

The only hardware stereo mode that can be supported is Above/Below.

Open the *Monitor and Sounds* Control Panel, display all resolutions (not only the recommended ones) and figure out if the monitor supports a resolution with 60Hz or below. If this is so, there is a good chance that it can support Above/Below stereo. Note that the stereographics device has to be connected between your monitor and your computer. As the cable has an HD15 plug, you need to check whether your monitor has an HD15 input. This is not likely to be the case on Apple monitors, in which case you will need an additional plug. Check with your Apple supplier what needs to be done in your case.

We have tested this successfully on a PowerMac 9600 with a 21 "multi-synch Apple" color monitor, and with a "SGI 20" color monitor.

PC (MS windows):

Two hardware stereo modes are supported: Above/Below and OpenGL Stereo.

DeepView uses Above/Below format for all graphic cards that do not support quadbuffer OpenGL Stereo in the current video mode. If you activate the *Use hardware Stereo (Top/Bottom)* option on the *Stereoscopic View Settings* dialog (see point 168), you will see 2 pictures separated on the top and bottom of the screen. To get a good stereo perception, you may have to adjust the vertical offset of the 2 pictures with the up and down keyboard arrows (while in stereo).

We have tested this mode successfully on an HP Kayak workstation with an HP1100 monitor. (This mode also supports DiamondFireGL400 video card). Make sure your graphic card is running with the correct vertical refresh rate (e.g. 60Hz) before switching your emitter (e.g. EPC2) to stereo.

Provided that OpenGL stereo is supported by your graphic card, DeepView automatically uses it as the default hardware stereo format. You should see both left- and right-eye views superposed in one window.

We have tested this mode successfully on an HP visualize fx4 video card with an HP1100 monitor.

SGI:

The only hardware stereo mode supported for now is Above/Below (STR_RECT).

In principle SGIs are ready for stereo display, but you might need additional adaptators on certain machines, and an emitter in all cases.

We have tested this successfully on an Indy with a SGI 20" monitor.

Linux:

The only hardware stereo mode supported is Above/Below.

DeepView will determine different video modes supported by your hardware from the configuration file */etc/X11/XF86Config*.

While switching to stereo view, the program will install a video mode with a lower vertical refresh rate to stay within monitor limits when you activate your emitter. On switching back to mono view it will reinstall your previous settings.

Example:

In the following it is assumed that you are using a resolution of 1280 times 1024, with an appropriate vertical refresh rate. We want to add a new video mode at 1600 times 1200, which the program will use to display the stereo view. You have to adjust your configuration file for the X server (*/etc/X11/XF86Config*) as following:

1- The entry in "VertRefresh" must match your monitor's hardware limits: check your hardware manual for correct settings to prevent monitor damage. In our example we use "VertRefresh 40-120".

2- Enter a new modeline with a new screen resolution., e.g.

```
Modeline "1600x1200" 135.00 1600 1604 1688 1928 1200 1225 1228 1262
```

where "1600x1200" is the resolution, 135.00 is the pixel clock in MHz, the first block of four figures are the horizontal rates, and the last four figures are the vertical rates. Htotal is 1928 and Vtotal is 1262.

You can adjust these settings with the program "xvidtune", once it is in the config file. The total vertical frequency of the mode should not be more than half the maximum your monitor supports. You can calculate the vertical refresh frequency in Hz with the formula: $\text{pixel_clock} * 1000 * 1000 / \text{htotal} / \text{vtotal}$

3- Make the new mode active in your X server's section "Screen" in the config file. Change the line "Modes" in the subsection "Display" to contain the previously defined mode, e.g.

```
Modes "1600x1200" "1280x1024"
```

We have tested this successfully on a HP vectraVE with a 21" Compaq Qvision210 monitor.

ANNEX 4: CALCULATIONS

I. CONNECT

DeepView will read the CONECT cards in PDB files and use them to generate bonds, provided they are plausible. If no CONNECT cards are present DeepView will try to guess the correct molecular structure from the atomic coordinates. You can use a text editor to manually add a connection to a PDB file:

Example: to connect a single atom to an amino acid, where 2967 is the atom number of the single atom, and 58 is the atom number of the amino acid atom that has to be connected to the single atom.

```
CONNECT 2967      58
```

Note that if the distance between the two atoms is extravagant will not make the connection when loading the file, instead it will prompt a warning message. Before editing a PDB file, make sure you have a look at the PDB format definition: <http://www.rcsb.org/pdb/info.html>

II. SECONDARY STRUCTURE DETECTION

DeepView is (currently) not using the secondary structure described in the PDB file header. Instead, the secondary structure is newly assigned by the following procedure:

if $((\phi < -20.0) \text{ and } (\phi > -110.0))$ and if $((\psi < 15.0) \text{ and } (\psi > -80.0))$ an alpha helix is temporarily assigned.

Only "helix nucleation sites" of more than 4 residues are kept and "elongated" in both C and N terminal direction, using the H-bonding pattern.

Long helices are then broken into two helices if they "bend" too much, checking ϕ/ψ dihedral angles:

if $((\phi < -120.0) \text{ or } (\phi > 0.0))$ or if $((\psi < -100.0) \text{ or } (\psi > -10.0))$

Then non-helical residues are checked for strand using the H-bonding pattern, again each possible "sheet nucleation site" (two amino acids H-bonded possibly forming a sheet) are temporarily assigned as a strand. They are extended in N and C terminal, and then strands of less than 3 residues are destroyed.

There is a subsequent step of trimming the helices in order to make nicer ribbons. This is to avoid the problem when residues could be assigned as both belonging to one helix and one strand.

III. MUTATIONS

When browsing through rotamer libraries, a simple clash score according to the following formula is provided (valid for *Rotolib1.aa* and *Rotolib2.aa* libraries): The “best rotamer” is the one that with the lowest score.

$$\begin{aligned} \text{Clash Score} = & 4 \times (\text{number of clashes with backbone N, CA, and C atoms}) \\ & + 3 \times (\text{number of clashes with backbone O atoms}) \\ & + 2 \times (\text{number of clashes with side chains atoms}) \\ & - \text{number of H bonds} \\ & - 4 \times (\text{number of SS bonds}) \end{aligned}$$

IV. BUILDING LOOPS

Similarity score:

Score = sum of amino-acid exchange penalty scores for the currently selected alignment matrix

Clash score:

Score = see above

Angle evaluation:

Score = deviation compared to an ideal closure angle

(see also RMS, Field Force Energy, and Threading Energy)

V. MOLECULAR SURFACES

Not yet described.

VI. ELECTROSTATIC POTENTIALS

Charge Model:

Currently, the protein is assumed to be at pH 7.0 with default protonation state for all residues. As default settings, only charged residues (Arg, Lys, Glu, Asp) are taken into account, and the charges are located at the corresponding (non-H) atom positions. You may also use the partial charges of the GROMOS 43A1 force field. This is much slower, as more charged atoms are present.

Coulomb approximation:

Simple Coulomb electrostatic potential computations are very fast, but not very accurate, as only a uniform dielectric constant is applied both for protein interior and for the solvent space. These

computations can only give a qualitative picture, indicating if it might be interesting to have a closer look using a more accurate method.

Poisson-Boltzmann

If we want to account for the different dielectric properties of the protein interior and the solvent, we have to numerically solve the Poisson-Boltzmann equation [Klapper *et. al.* 1986]. This gives us a much more accurate picture of the electrostatic field around a protein. However, these computations are quite time consuming, and for large molecules you might want to use specialized software like DELPHI [Honig and Nicholls, 1995] for the computations. DeepView will be able to load and display these maps. (Note: The current implementation in DeepView is not able to take the solvent salt concentration into account.)

For more details about electrostatics in macromolecules, please see:

Honig and Nicholls (1995). *Science* **268**, 1144.

Anthony Nicholls, Kim Sharp and Barry Honig (1991). *Proteins*. **11**, 281.

<http://trantor.bioc.columbia.edu/delphi/>

VII. ELECTRON DENSITY MAPS

DeepView will read and display electron density maps in the following formats:

CCP4

<http://www.dl.ac.uk/CCP/CCP4/>

dn6 – Alwyn Jones O format

<http://imsb.au.dk/~mok/o/> (The O server)

<http://xray.bmc.uu.se/usf/> (Uppsala Software Factory)

XPLOR maps

The Uppsala University is providing an electron density server containing electron density maps for many PDB entries: <http://portray.bmc.uu.se/eds/>

NOTE: Although DeepView can display electron density maps, it has not been designed for crystallographic structure solution, i.e. you will not find elaborated functions for model building or map manipulations.

VIII. SOLVENT ACCESSIBILITY

DeepView defines the maximum accessibility as the accessible surface area for residue X in an extended pentapeptide GGXGG. The relative accessibility of a residue X is obtained by comparison of the observed accessibility to this reference value of 100%. Colors range from dark blue for completely buried amino acids, to red for residues with at least 75% of their maximum surface exposure.

NOTE: The numerical values for each residue can be accessed via the scripting language command "access".

IX. MATRICES

They are located in the usrstuff/matrix directory. Standard exchange matrices used by other programs (FASTA, Blast) can be used.

X. THREADING ENERGY / MEAN FORCE POTENTIAL (PP)

Not yet described

XI. FORCE FIELD ENERGY (FF)

Swiss-PdbViewer includes a version of the GROMOS 43B1 force field. It allows evaluating the energy of a structure as well as repairing distorted geometry through energy minimization. In this implementation, all computations are done in vacuo, without reaction field.

GROMOS96:

W.F. van Gunsteren et al. (1996) in Biomolecular simulation: the GROMOS96 manual and user guide. Vdf Hochschulverlag ETHZ.
<http://igc.ethz.ch/gromos/welcome.html>

XII. TRANSFORMATION MATRICES

Not yet described

XIII. RMSD

Not yet described

XIV. SEQUENCE SIMILARITY

Not yet described

ANNEX 5: GLOSSARY

References

Sequence Alignment:

BLAST:

Altschul S.F., Gish W., Miller W., Myers E.W., Lipman D.J. (1990). Basic local alignment search tool. *J. Mol. Biol.* 215:403-410.

SIM:

Huang, X., and Miller, M. (1991) A time-efficient, linear-space local similarity algorithm. *Adv. Appl. Math.* 12,337-367.

Molecular Graphics:

RIBBONS:

Carson, M. (1987) Ribbon model of macromolecules. *J. Mol. Graphics.* 5, 103-106.

MSMS:

Michael F. Sanner, Olson & Spohner, *Biopolymers* (1996) 38, 305

GRASP:

Anthony Nicholls, Kim Sharp and Barry Honig; *Proteins* (1991) 11, 281.

Electrostatics:

DELPHI / GRASP:

Honig and Nicholls (1995). Classical Electrostatics in Biology and Chemistry. *Science* 268, 1144.

Anthony Nicholls, Kim Sharp and Barry Honig (1991). *Proteins.* 11, 281.

Klapper I, Hagstrom, R. Fine, R. Honig, B. (1986). Focussing of Electric Fields in the Active Site of Cu-Zn Superoxide Dismutase: Effects of Ionic Strength and Amino-Acid Modification. *Proteins* 1, 47-59.

Homology Modelling:

DeepView & SWISS-MODEL:

Peitsch MC and Jongeneel V (1993) A 3-dimensional model for the CD40 ligand predicts that it is a compact trimer similar to the tumor necrosis factors. *Int. Immunol.* 5:233-238.

Peitsch MC (1995) ProMod: automated knowledge-based protein modelling tool. *PDB Quarterly Newsletter* 72:4.

Peitsch MC (1995) Protein modelling by E-Mail. *Bio/Technology* 13:658-660.

Peitsch MC (1996) ProMod and Swiss-Model: Internet-based tools for automated comparative protein modelling. *Biochem. Soc. Trans.* 24:274-279.

Peitsch MC and Herzyk P (1996) Molecular modelling of G-protein coupled receptors. in: *G Protein-coupled Receptors. New opportunities for commercial development*, vol 6, p 6.29-6.37, N Mulford and LM Savage eds. IBC Biomedical Library Series.

Peitsch MC, Herzyk P, Wells TNC and Hubbard RE (1996) Automated modelling of the transmembrane region of G-protein coupled receptor by Swiss-Model. *Receptors and Channels* 4:161-164.

Peitsch MC, Wilkins MR, Tonella L, Sanchez J-C, Appel RD and Hochstrasser DF (1997) Large scale protein modelling and integration with the SWISS-PROT and SWISS-2DPAGE databases: the example of *Escherichiacoli*. *Electrophoresis.* 18:498-501.

Peitsch MC (1997) Large scale protein modelling and model repository. in: Proceedings of the fifth international conference on intelligent systems for molecular biology, vol 5, p 234-236, Gaasterland T, Karp P, Karplus K, Ouzounis C, Sander C and Valencia A eds., AAAI Press.

Peitsch MC and Guex N (1997) Large-scale comparative protein modelling. in: Proteome research: new frontiers in functional genomics, p 177-186, Wilkins MR, Williams KL, Appel RO, Hochstrasser DF eds., Springer.

Guex N and Peitsch MC (1997) SWISS-MODEL and the Swiss-PdbViewer: An environment for comparative protein modelling. *Electrophoresis* 18:2714-2723.

Guex N and Peitsch MC (1999) Molecular modelling of proteins. *Immunology News* 6:132-134.

Guex N, Diemand A and Peitsch MC (1999) Protein modelling for all. *TiBS* 24:364-367.

Nicolas Guex, Torsten Schwede, and Manuel C. Peitsch (2000), Protein Tertiary Structure Modeling, *Current Protocols in Protein Science*: 2.8.1-2.8.17

SC Lovell, JM Word, JS Richardson and DC Richardson (2000) " The Penultimate Rotamer Library" *Proteins: Structure Function and Genetics* 40 389-408

Energy Minimisation / Force Fields

GROMOS96:

W.F. van Gunsteren et al. (1996) in Biomolecular simulation: the GROMOS96 manual and user guide. Vdf Hochschulverlag ETHZ.

Sippl, J.M. (1990) Calculation of Conformational Ensembles from Potentials of Mean Force: an approach to the knowledge based prediction of local structures in globular proteins. *J. Mol. Biol.* **213**, 859-883.

Glossary

(1)- Norah Rudin (1997), *Dictionary of Modern Biology*, Barron's Educational Series Inc., 504 pp.

(2)- ISO/AFNOR (1997), *Dictionary of Computer Science- The Standardized Vocabulary*,

(3)- Nicolas Guex, Torsten Schwede, and Manuel C. Peitsch (2000), Protein Tertiary Structure Modeling, *Current Protocols in Protein Science*: 2.8.1-2.8.17

(4)- Jackie Neider, Tom Davis and Mason Woo, Addison-Wesley (1993), *OpenGL Programming Guide -- The Official Guide to Learning OpenGL, Release 1, OpenGL Architecture Review Board*.

(5) Dong Xu and Ying Xu (2000), Protein Tertiary Structure Prediction, *Current Protocols in Protein Science*: 2.7.1-2.7.17

